

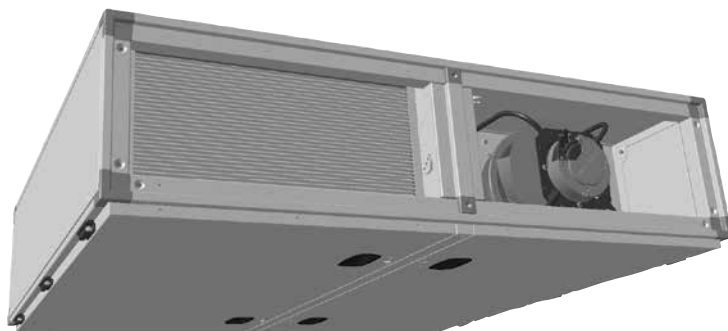

Schakelschema ventilatietoestel

CFL-15 Elektrisch naverwarmingsregister



| | | | | | | | | | | | | | | | | | | | | | | | | | | | | | | | | | | | | | | | | | | | | | | | | | |
|--|-------------------------|--------------------|------------|----------------|--|---|---|-------------------|--------------------------|-----------------|-------------------------|-------|-----------------------|---------------|-------|-------------------|------------|--------------------|-------------------|------------|--|------|-----|----------------|--|--|--|--|--|--|--|-------|----------|---------------|----------------|--|--|--|--|------------------|--------------|-------------|--|--|--|--|--|--|--|
| 0 | 1 | 2 | 3 | 4 | 5 | 6 | 7 | 8 | 9 | | | | | | | | | | | | | | | | | | | | | | | | | | | | | | | | | | | | | | | | |
| F26_001_Wolf_Standard | | | | | | | | | | | | | | | | | | | | | | | | | | | | | | | | | | | | | | | | | | | | | | | | | |
|  | | | | | WOLF GmbH Industriestraße 1 D-84048 Mainburg Tel. +49 (0)8751 74-0 | | | | | | | | | | | | | | | | | | | | | | | | | | | | | | | | | | | | | | | | | | | | |
| <h1>Elektrotechnische documentatie</h1> | | | | | | | | | | | | | | | | | | | | | | | | | | | | | | | | | | | | | | | | | | | | | | | | | |
| <table border="1" style="width: 100%; border-collapse: collapse;"> <tr> <td style="width: 30%;">Apparaat</td> <td style="width: 30%;">CFL15 E-register, KW</td> <td style="width: 40%;"></td> </tr> <tr> <td>Tekeningnummer</td> <td>62-34-015-005</td> <td></td> </tr> <tr> <td>Gemaakt op</td> <td>04.04.2017</td> <td rowspan="2" style="text-align: right; vertical-align: middle;">Aantal pagina's 16</td> </tr> <tr> <td>Bewerkt op</td> <td>07.04.2017</td> </tr> </table> | | | | | | | | | | Apparaat | CFL15 E-register, KW | | Tekeningnummer | 62-34-015-005 | | Gemaakt op | 04.04.2017 | Aantal pagina's 16 | Bewerkt op | 07.04.2017 | | | | | | | | | | | | | | | | | | | | | | | | | | | | | |
| Apparaat | CFL15 E-register, KW | | | | | | | | | | | | | | | | | | | | | | | | | | | | | | | | | | | | | | | | | | | | | | | | |
| Tekeningnummer | 62-34-015-005 | | | | | | | | | | | | | | | | | | | | | | | | | | | | | | | | | | | | | | | | | | | | | | | | |
| Gemaakt op | 04.04.2017 | Aantal pagina's 16 | | | | | | | | | | | | | | | | | | | | | | | | | | | | | | | | | | | | | | | | | | | | | | | |
| Bewerkt op | 07.04.2017 | | | | | | | | | | | | | | | | | | | | | | | | | | | | | | | | | | | | | | | | | | | | | | | | |
| <table border="1" style="width: 100%; border-collapse: collapse;"> <tr> <td style="width: 10%;">02</td> <td style="width: 10%;">KIJER</td> <td style="width: 10%;">Datum</td> <td style="width: 10%;">07.04.2017</td> <td style="width: 10%;">Apparaat</td> <td style="width: 10%;">CFL15</td> <td style="width: 10%;"></td> <td style="width: 10%;"></td> <td style="width: 10%;"></td> <td style="width: 10%;"></td> </tr> <tr> <td></td> <td></td> <td>Bew.</td> <td>Kür</td> <td>E-register, KW</td> <td></td> <td></td> <td></td> <td></td> <td></td> </tr> <tr> <td></td> <td></td> <td>Gepr.</td> <td>herkomst</td> <td>62-34-015-005</td> <td>Vervangen door</td> <td></td> <td></td> <td></td> <td></td> </tr> <tr> <td>Wijziging</td> <td>Datum</td> <td>Naam</td> <td></td> <td></td> <td></td> <td></td> <td></td> <td></td> <td></td> </tr> </table> | | | | | | | | | | 02 | KIJER | Datum | 07.04.2017 | Apparaat | CFL15 | | | | | | | Bew. | Kür | E-register, KW | | | | | | | | Gepr. | herkomst | 62-34-015-005 | Vervangen door | | | | | Wijziging | Datum | Naam | | | | | | | |
| 02 | KIJER | Datum | 07.04.2017 | Apparaat | CFL15 | | | | | | | | | | | | | | | | | | | | | | | | | | | | | | | | | | | | | | | | | | | | |
| | | Bew. | Kür | E-register, KW | | | | | | | | | | | | | | | | | | | | | | | | | | | | | | | | | | | | | | | | | | | | | |
| | | Gepr. | herkomst | 62-34-015-005 | Vervangen door | | | | | | | | | | | | | | | | | | | | | | | | | | | | | | | | | | | | | | | | | | | | |
| Wijziging | Datum | Naam | | | | | | | | | | | | | | | | | | | | | | | | | | | | | | | | | | | | | | | | | | | | | | | |
| | | | | | | |  | | Titelblad/voorblad | | | | | | | | | | | | | | | | | | | | | | | | | | | | | | | | | | | | | | | | |
| | | | | | | | 62-34-015-005 | | = + | | | | | | | | | | | | | | | | | | | | | | | | | | | | | | | | | | | | | | | | |
| | | | | | | | Afd.: TR | EPLAN P8 2.6.3 | Art.Nr. 3063813_NL | | | | | | | | | | | | | | | | | | | | | | | | | | | | | | | | | | | | | | | | |
| | | | | | | | | | Blad van 16 Blad 1 | | | | | | | | | | | | | | | | | | | | | | | | | | | | | | | | | | | | | | | | |

Kleuren bedrading:

- Primaire stroomkring : zwart
- Nulleider : lichtblauw
- Aardleiding : geel/groen
- Stuurkring voor wisselstroom : rood/ roodwit
- Stuurkring voor gelijkstroom : donkerblauw/ donkerblauw/wit
- Potentiaalvrij contact (parasitaire spanning) : oranje

OPGELET!!

Let vóór ingebruikname van de schakelkast op het volgende:

1. Alle aansluitingen dienen conform voorschriften van het plaatselijke elektriciteitsbedrijf te worden aangelegd
2. Alle verbindings- en contactschroeven, evenals de contacten die niet zijn toegewezen, moeten worden gecontroleerd op stevig vastzitten. (Door transport kunnen deze loslaten.)
3. De gebruikte motorbeveiligingsschakelaars voor de EC-ventilatoren en E-registers worden als leidingbeveiligingsschakelaars gebruikt, en moeten niet op de nominale stroom ingesteld worden..
4. Vergelijk de netspanning met de aansluitspanning van de schakelkast.
 - 5. Kabellengte voor voeler/servomotoren, 24 V-stuurkabels max. 50 m. Niet gelijkmatig plaatsen met 230/400 V-kabels of geïsoleerde kabels gebruiken
 - 6. Aangeboden kabeldiameters zijn minimum doorsneden voor koperen leidingen zonder de lengte van de kabel en de omstandigheden ter plaatse. Kabel types worden geselecteerd op basis van de routing.
 - 7. Om de vorstbescherming van de installatie te waarborgen is het niet toegestaan hoofdschakelaar Q1 uit te schakelen..
 - 8. Aardlekbeveiliging RCD Alleen voor alle stroomsoorten gevoelige FI-aardlekschakelaars type B met 300 mA toegelaten..

| | | | | | | | | | |
|-----------|------------|------|-------|---------------|----------------|----------------|----------------------------|--------------------|-------------|
| 02 | 04.04.2017 | KUER | Datum | 07.04.2017 | Apparaat | CFL15 | AANWIJZINGEN INGEBRUIKNAME | 62-34-015-005 | = |
| | | | Bew. | Kur | E-register, KW | | | | + |
| Wijziging | Datum | Naam | Gepr. | Herkomst | Vervangen door | Vervangen door | | Afd.: TR | |
| | | | | 62-34-015-005 | | | | EP/JAN P8 | |
| | | | | | | | | 2.6.3 | |
| | | | | | | | | Art.Nr. 3063813_NL | |
| | | | | | | | | | Blad |
| | | | | | | | | | van 16 Blad |

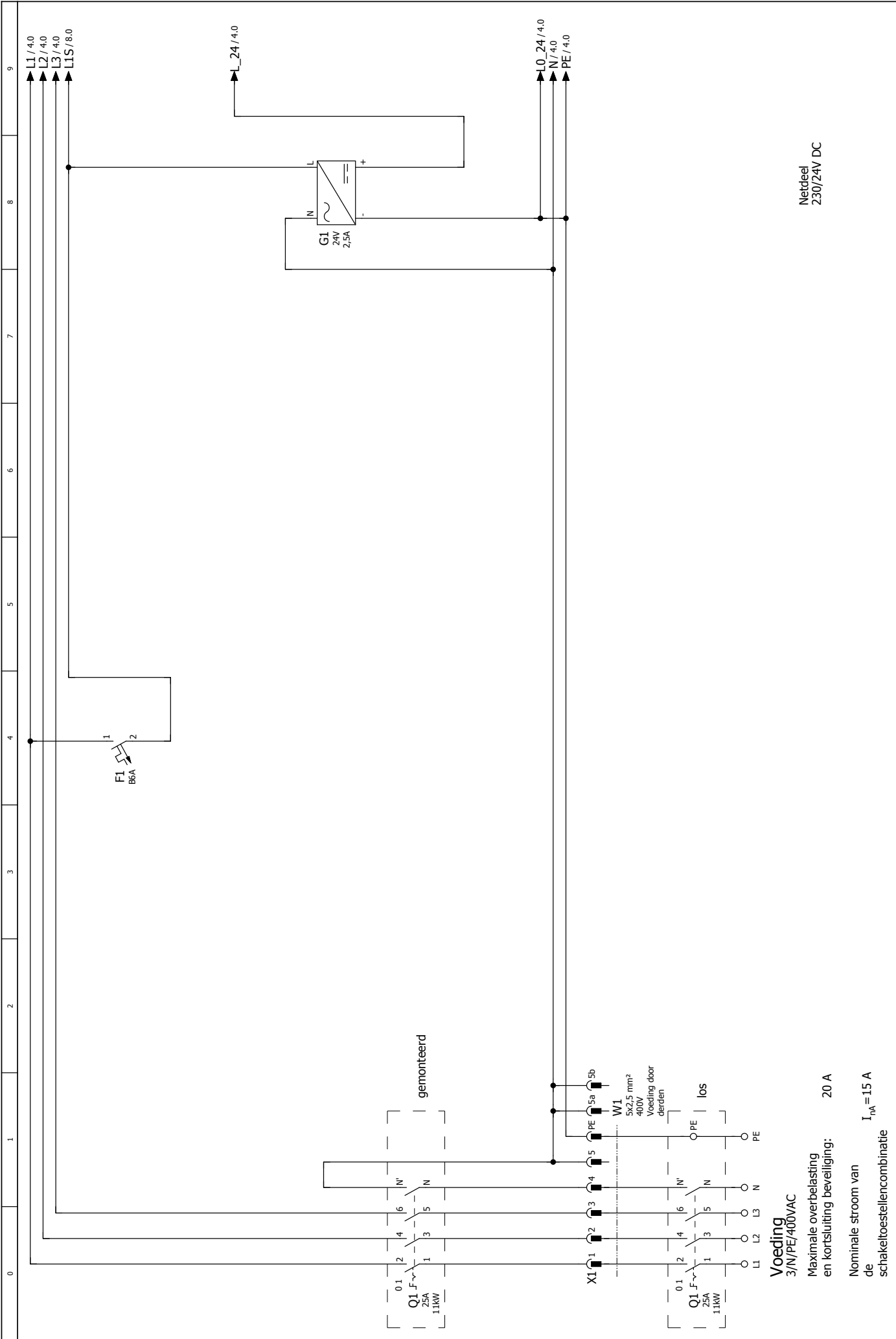

Netdeel
230/24V DC

| | | | | | | | | |
|-----------|------------|-------|-------|---------------|----------------|-------|-----------------|--------------------|
| 02 | 04.04.2017 | KUJER | Datum | 04.04.2017 | Apparaat | CFL15 | VOEDING | |
| | | | Bew. | Kijr | E-register, KW | | HOOFDSCHAKELAAR | |
| Wijziging | Datum | Naam | Gepr. | herkomst | Vervangen door | | STUURTRAFO | |
| | | | | 62-34-015-005 | Vervangen door | | | |
| | | | | | | | 62-34-015-005 | |
| | | | | | | | Afd.: TR | Art.Nr. 3063813_NL |
| | | | | | | | EPLAN P8 | |
| | | | | | | | 2.6.3 | |
| | | | | | | | Blad | 3 |
| | | | | | | | van 16 Blad | |



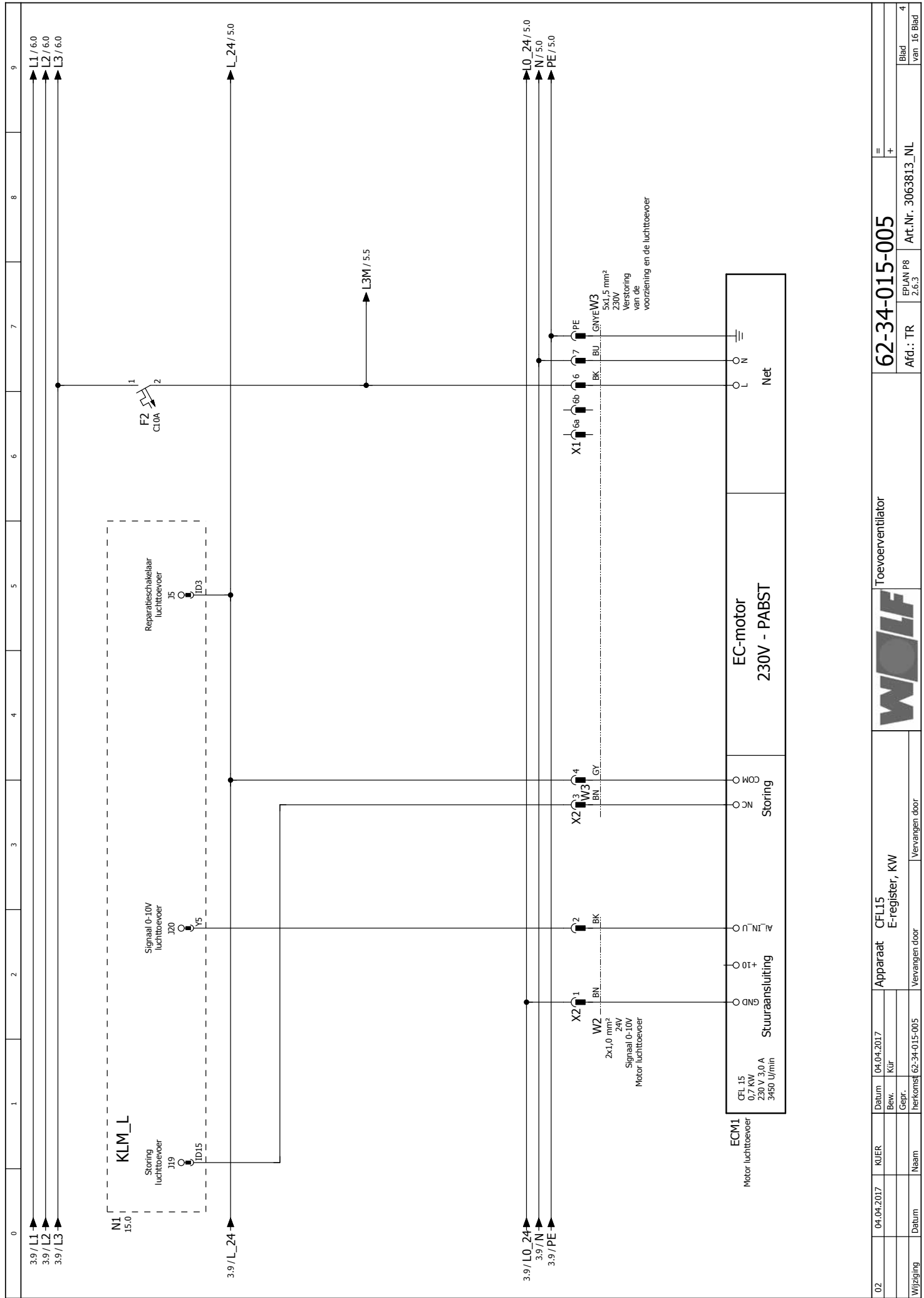

| | | | | | | | | | | | | | | | | | | | | | |
|-----------|------------|------|----------|---------------|----------------|----------------|----------|-------------------------|----------------------------|-----------------|---------|--------------------------|-------------------|---------------|----------|--------------------|--------------------|---|---|---------------------|---|
| 02 | 04.04.2017 | KUER | Datum | 04.04.2017 | Bew. | Kur | Apparaat | CFL15 E-register, KW | ECM1 Motor lichttoevoer | Stuuransluiting | Storing | EC-motor 230V - PABST | Toevoerventilator | 62-34-015-005 | Afd.: TR | EP/JAN P8 2.6:3 | Art.Nr. 3063813_NL | = | + | Blad van 16 Blad | 4 |
| Wijziging | Datum | Naam | Herkomst | 62-34-015-005 | Vervangen door | Vervangen door | | | | | | | | | | | | | | | |

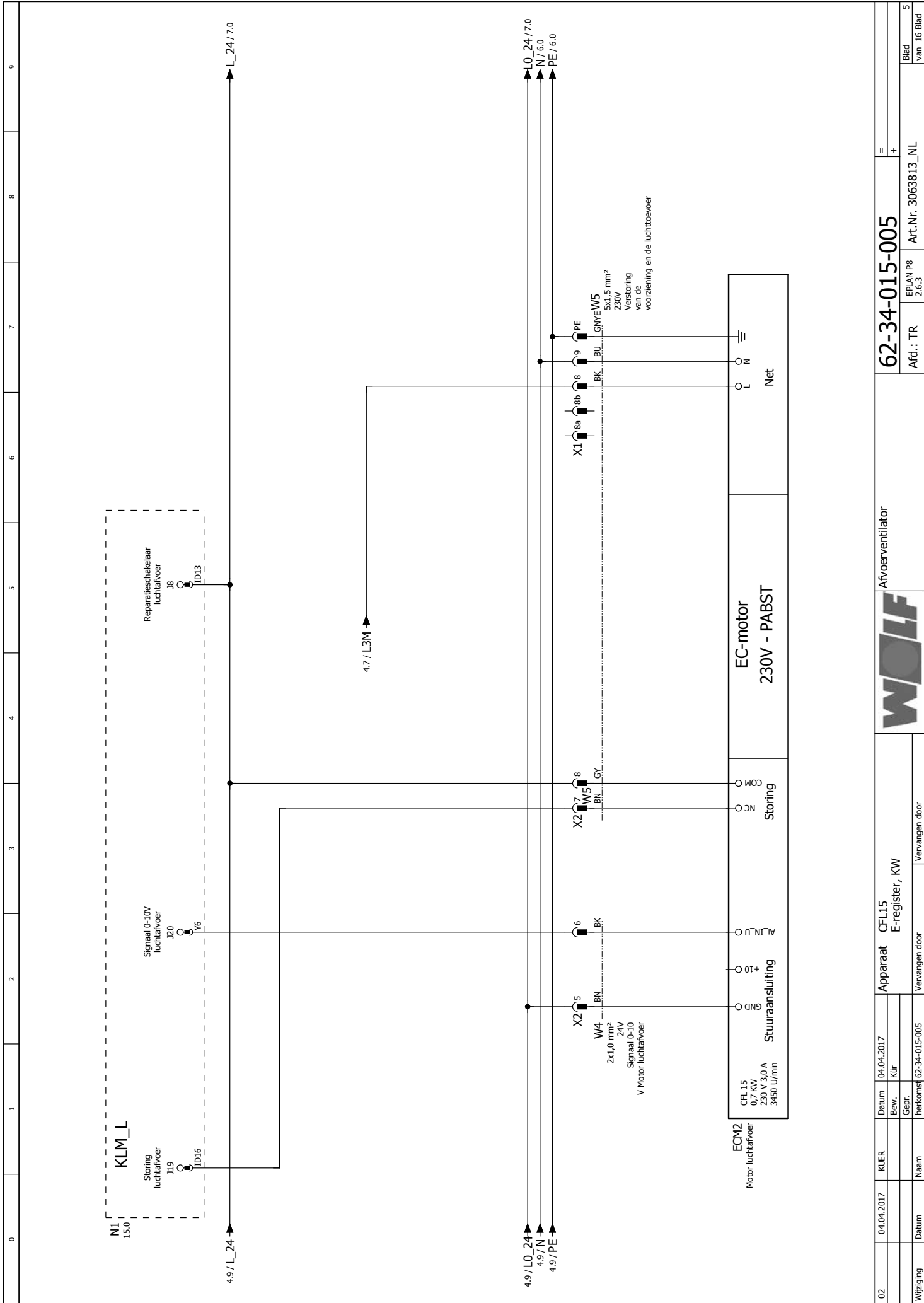

| | | | | | | | | | | | |
|-----------|------------|-------|-------|------------|---------------|----------------|----------|----------------|----------------|--------------------|-------------|
| 02 | 04.04.2017 | KUJER | Datum | 04.04.2017 | Apparaat | CFL15 | Apparaat | E-register, KW | Avroventilator | 62-34-015-005 | = |
| | | | Bew. | Kür | | | | | | | + |
| Wijziging | Datum | Naam | Gepr. | herkomst | 62-34-015-005 | Vervangen door | | Vervangen door | | Art.Nr. 3063813_NL | Blad |
| | | | | | | | | | | 2.6.3 | van 16 Blad |
| | | | | | | | | | | EPLAN P8 | 5 |
| | | | | | | | | | | Afd.: TR | |



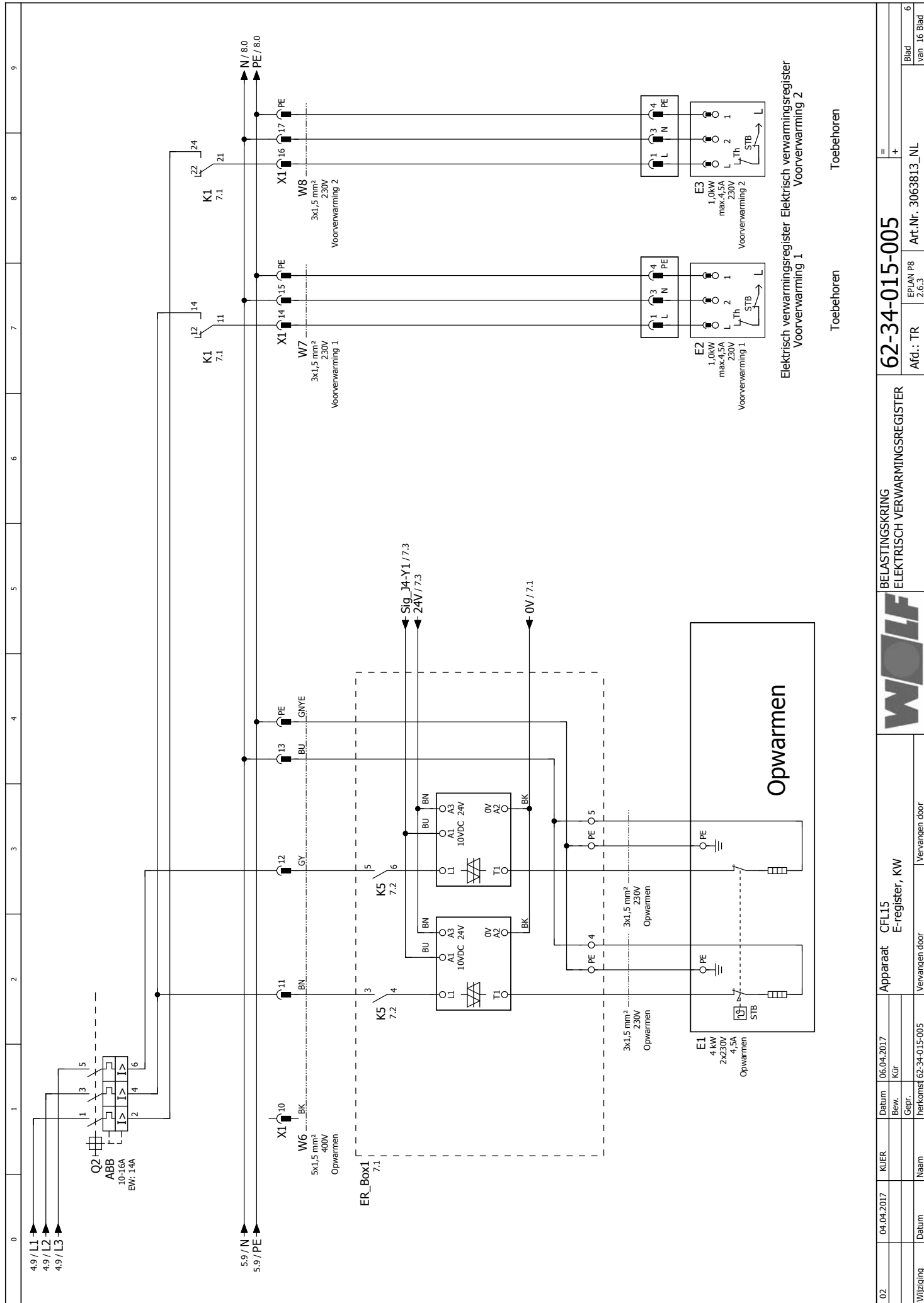

| | | | | | | | | | | | | |
|-----------|------------|------|----------|---------------|----------------|----------------|--------------------------------|---------------|------------|---|------|----|
| 02 | 04.04.2017 | KUER | Datum | 06.04.2017 | Apparaat | CFL15 | Belastingkring | 62-34-015-005 | EP/JAN P8 | = | Blad | 6 |
| | | | Bew. | KUR | E-register, KW | | Elektrisch verwarmingsregister | | 2.6.3 | + | van | 16 |
| Wijziging | Datum | Naam | Herkomst | 62-34-015-005 | Vervangen door | Vervangen door | Elektrisch verwarmingsregister | Art.-Nr. | 3063813_NL | | | |
| | | | | | | | Elektrisch verwarmingsregister | | | | | |
| | | | | | | | Voorverwarming 1 | | | | | |
| | | | | | | | Voorverwarming 2 | | | | | |

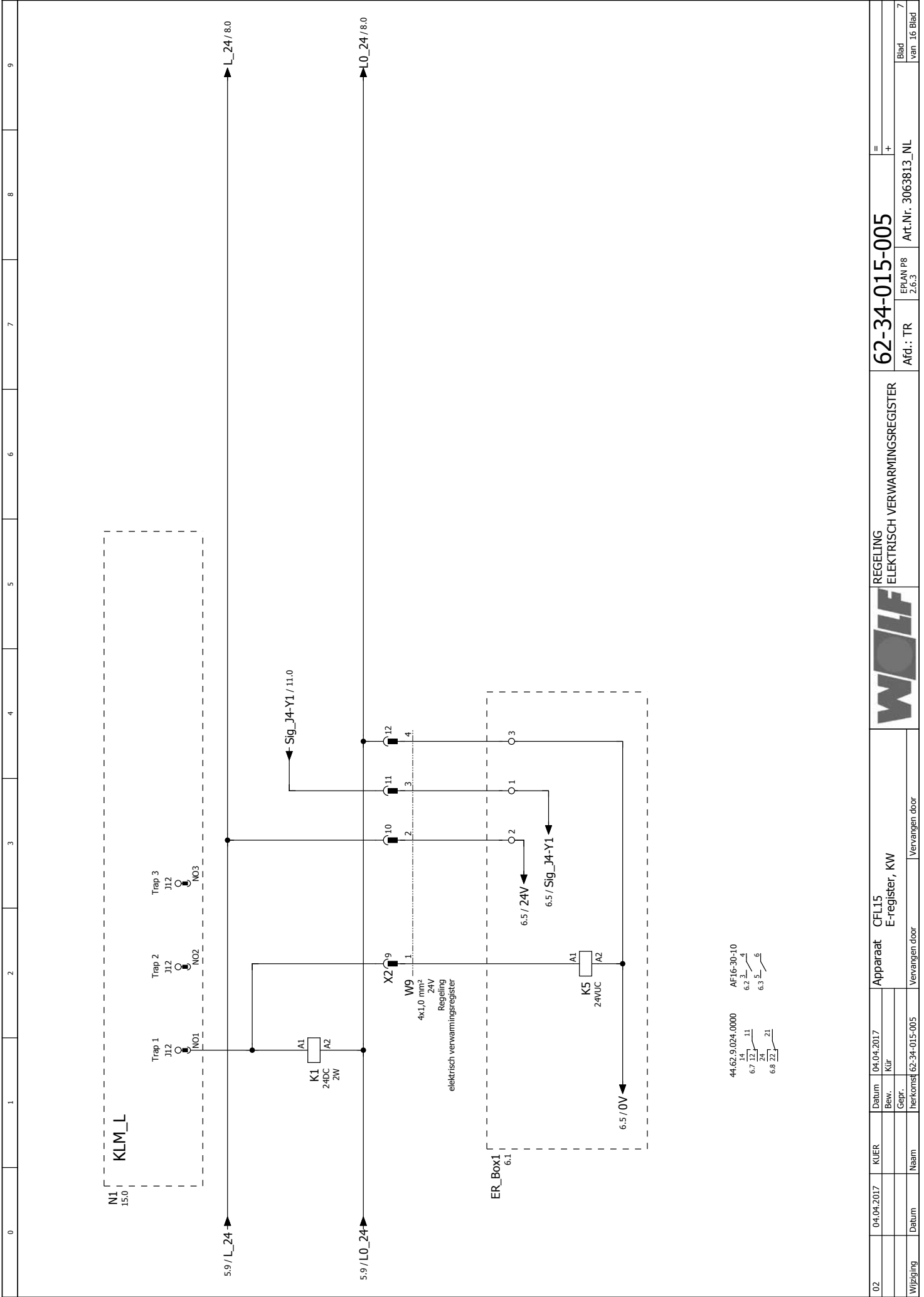

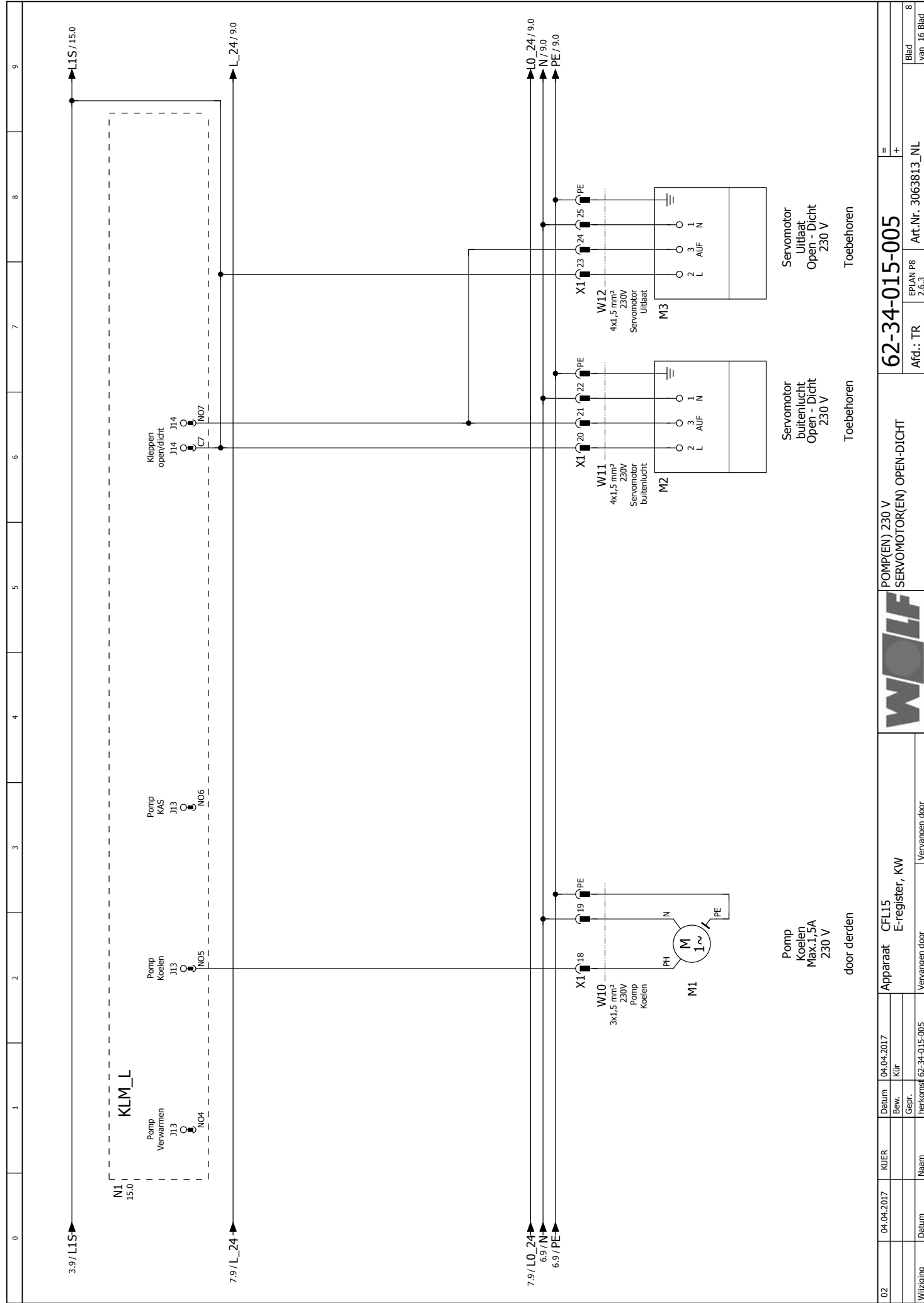

POMP(EN) 230 V
SERVOMOTOR(EN) OPEN-DICHT

62-34-015-005

Afd.: TR EP/JAN P8 2.6:3 Art.-Nr. 3063813_NL

Blad van 16 Blad 8

Apparaat CFL15 E-register, KW

| | | | | |
|-----------|------------|------|----------|---------------|
| 02 | 04.04.2017 | KUER | Datum | 04.04.2017 |
| | | | Bew. | KUR |
| | | | Geprt. | |
| Wijziging | Datum | Naam | Herkomst | 62-34-015-005 |

Vervangen door

Vervangen door

Vervangen door

Vervangen door

Vervangen door

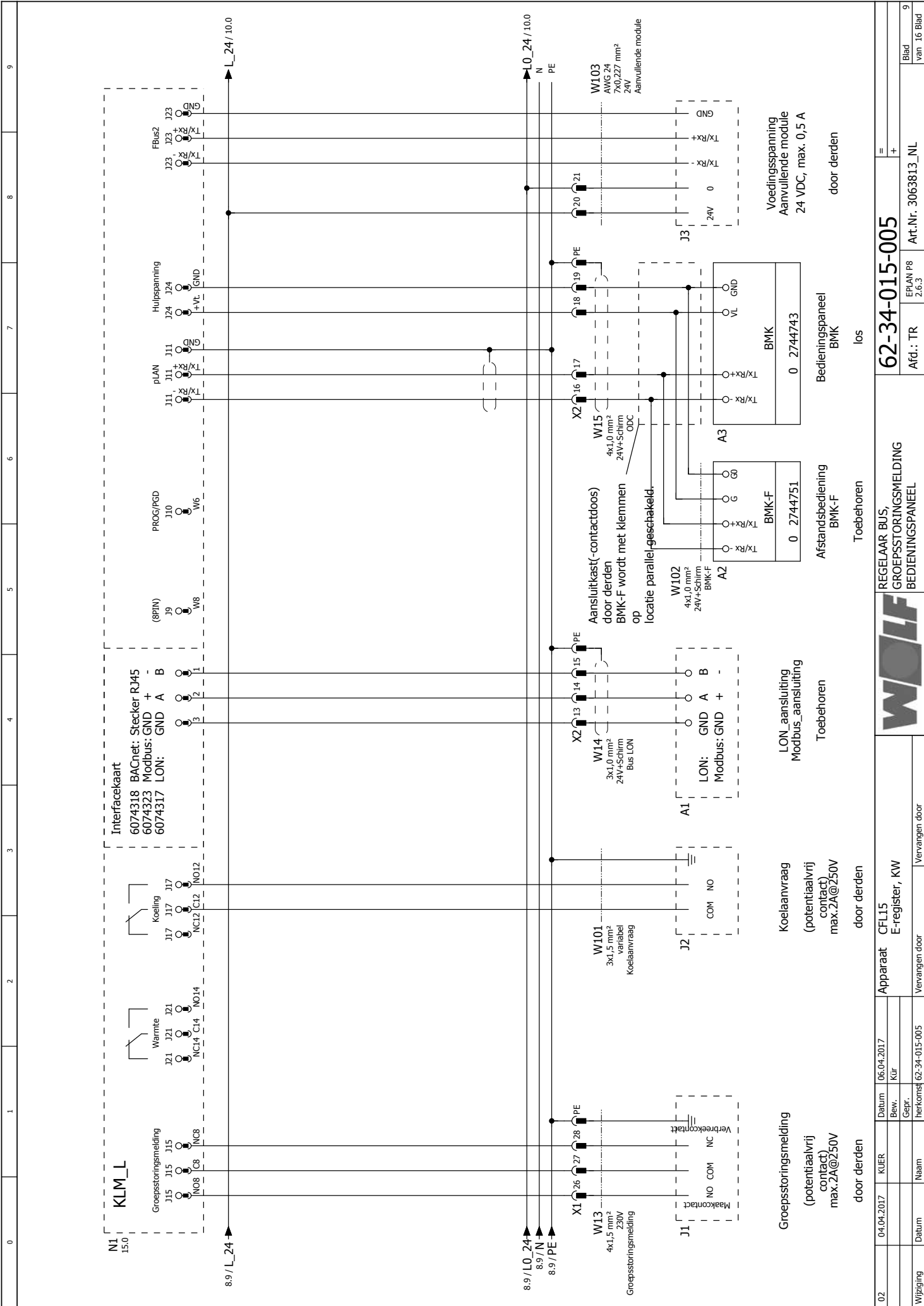

| | | | | | | | | | | |
|----|------------|-------|----------|---------------|----------------|-------|---|---------------|--------------------|------------------|
| 02 | 04.04.2017 | KUJER | Datum | 06.04.2017 | Apparaat | CFL15 | REGELAAR BUS, GROEPSSTORINGSMELDING, BEDIENINGSPANEEL | 62-34-015-005 | Art.Nr. 3063813_NL | Blad van 16 Blad |
| | | | Bew. | KUJ | E-register, KW | | | | | |
| | | | Gepr. | | Vervangen door | | | | | |
| | | | herkomst | 62-34-015-005 | Vervangen door | | | | | |

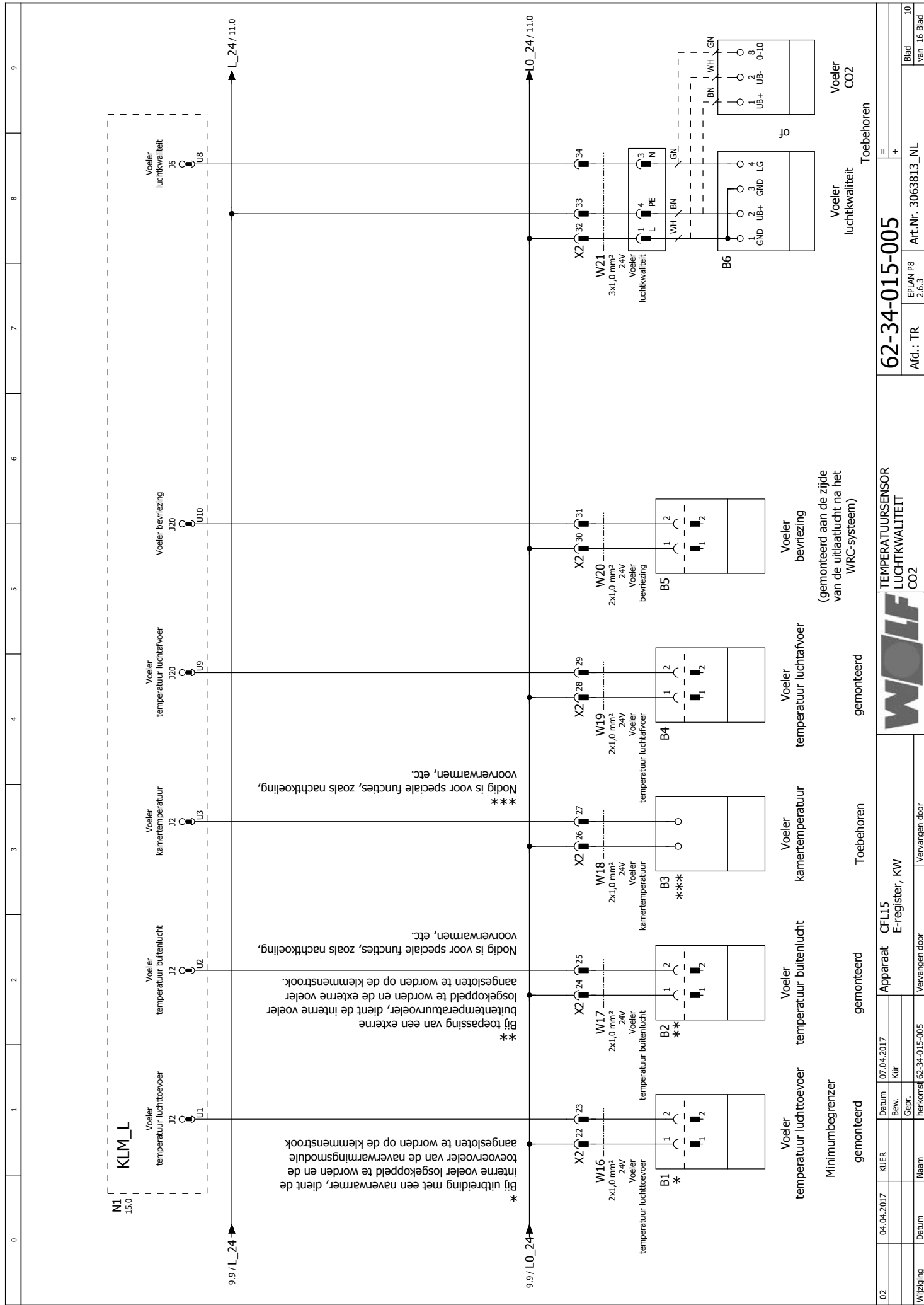

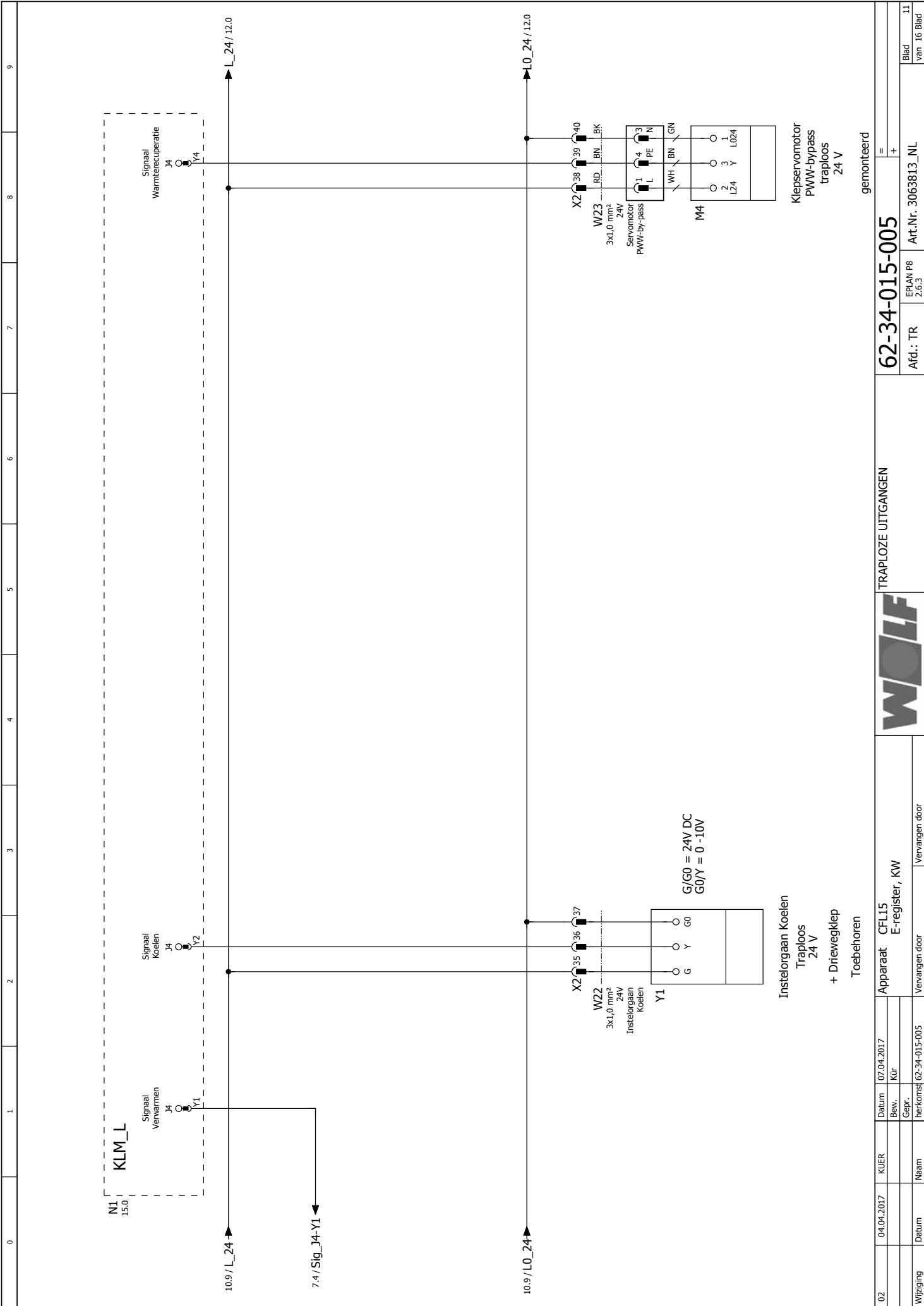

| | | | | | | | | | | | | | |
|-----------|------------|-------|-------|------------|----------------|----------------|--|---|--------------------|---------------|--------------------|------------|--|
| 02 | 04.04.2017 | KUJER | Datum | 07.04.2017 | Apparaat | CFL15 | |  | TRAPLOZE UITGANGEN | 62-34-015-005 | = | gemonteerd | |
| | | | Bew. | Klir | E-register, | KW | | | Afd.: TR | EPLAN P8 | Art.Nr. 3063813_NL | + | |
| | | | Gepr. | herkomst | 62-34-015-005 | Vervangen door | | | | 2.6.3 | | | |
| Wijziging | Datum | Naam | | | Vervangen door | | | | | | Blad | | |
| | | | | | Vervangen door | | | | | | van 16 Blad | | |

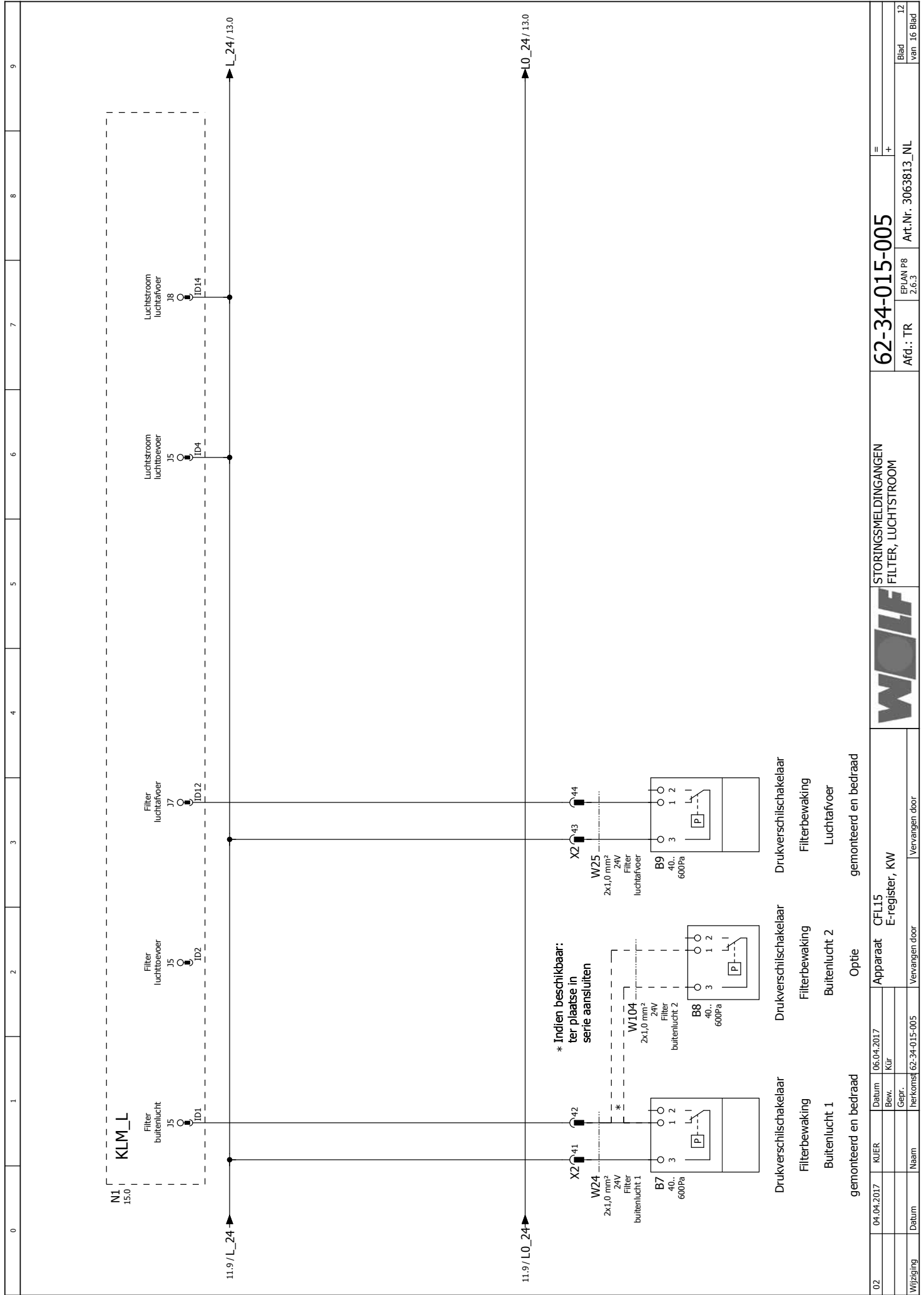

| | | | | | | | | | |
|-----------|------------|------|----------|---------------|----------------|----------------|---|----------------------|---------------------|
| 02 | 04.04.2017 | KJER | Datum | 06.04.2017 | Apparaat | CFL15 | STORINGSMELDINGANGEN FILTER, LUCHTSTROOM | 62-34-015-005 | = |
| | | | Bew. | Kur | E-register, KW | + | | | |
| Wijziging | Datum | Naam | Herkomst | 62-34-015-005 | Vervangen door | Vervangen door | | | |
| | | | | | | | Afd.: TR | EP/JAN P8 2.6.3 | Art.Nr. 3063813_NL |
| | | | | | | | | | Blad van 16 Blad |



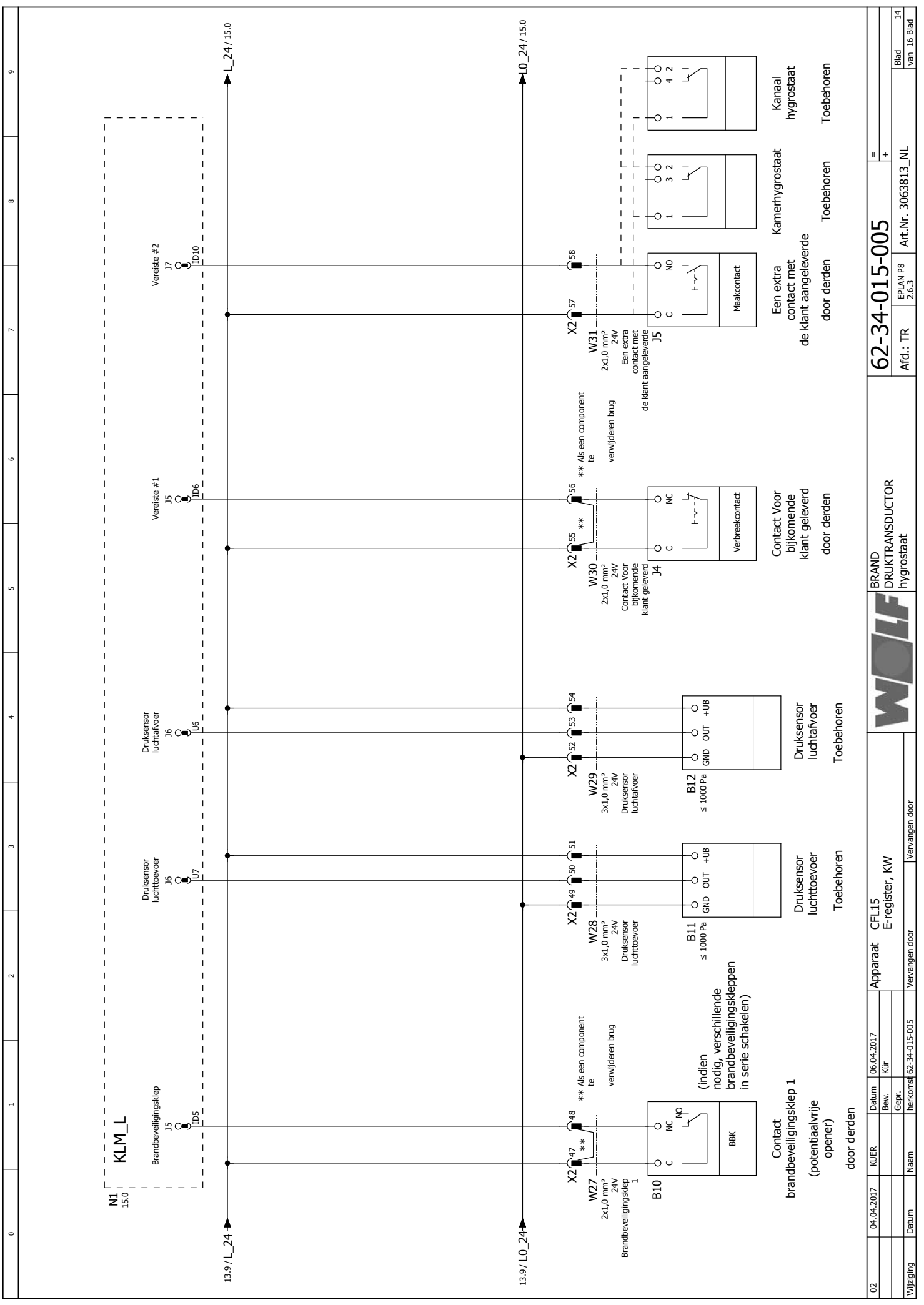

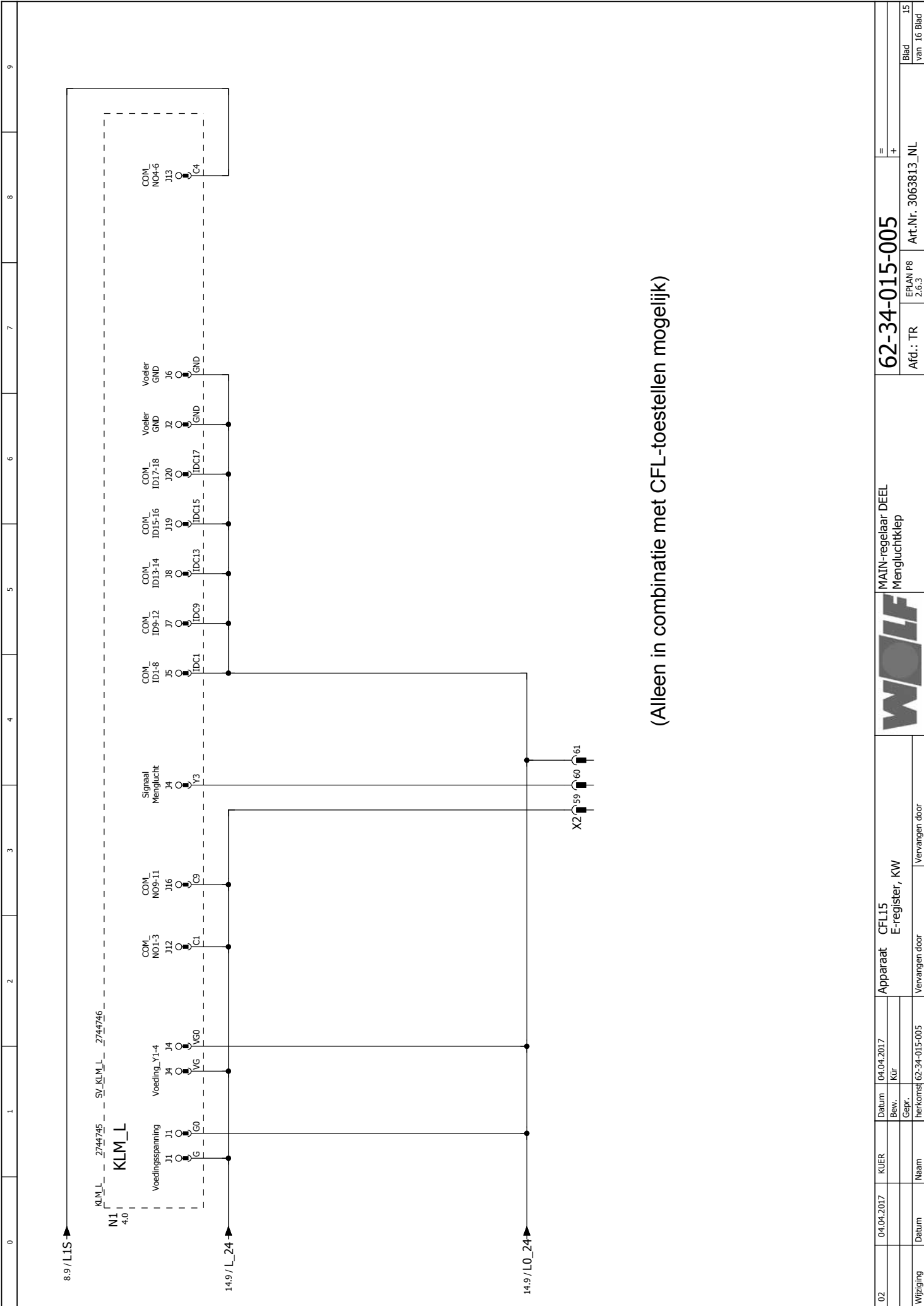

(Alleen in combinatie met CFL-toestellen mogelijk)

| | | | | | | | | | |
|-----------|------------|-------|-------|------------|---------------|-------------------------|--|---------------|-------------------|
| 02 | 04.04.2017 | KUJER | Datum | 04.04.2017 | Apparaat | CFL15 E-register, KW |  MAIN-regelaar DEEL Mengluichtklep | 62-34-015-005 | = + |
| | | | Bew. | Kür | | | | Afd.: TR | EPLAN P8 2.6.3 |
| Wijziging | Datum | Naam | Gepr. | herkomst | 62-34-015-005 | Vervangen door | | | |
| | | | | | | Vervangen door | | | |

