

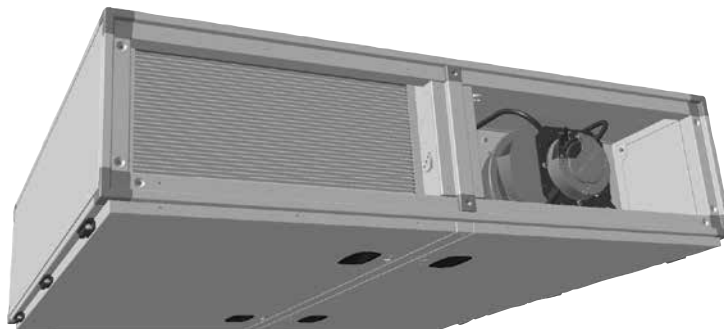



Schakelschema ventilatiestoel

CFL-22 Elektrisch naverwarmingsregister



0	1	2	3	4	5	6	7	8	9																																																
F26_001_Wolf_Standard																																																									
					WOLF GmbH Industriestraße 1 D-84048 Mainburg Tel. +49 (0)8751 74-0																																																				
					Elektrotechnische documentatie																																																				
<table border="1" style="width: 100%; border-collapse: collapse;"> <tr> <td style="width: 30%;">Apparaat</td> <td style="width: 40%;">CFL22 E-register, KW</td> <td style="width: 30%;">Aantal pagina's</td> <td style="width: 10%;">16</td> </tr> <tr> <td>Tekeningnummer</td> <td>62-34-022-005</td> <td></td> <td></td> </tr> <tr> <td>Gemaakt op</td> <td>04.04.2017</td> <td></td> <td></td> </tr> <tr> <td>Bewerkt op</td> <td>07.04.2017</td> <td>Van (afkorting)</td> <td>Kür</td> </tr> </table>										Apparaat	CFL22 E-register, KW	Aantal pagina's	16	Tekeningnummer	62-34-022-005			Gemaakt op	04.04.2017			Bewerkt op	07.04.2017	Van (afkorting)	Kür																																
Apparaat	CFL22 E-register, KW	Aantal pagina's	16																																																						
Tekeningnummer	62-34-022-005																																																								
Gemaakt op	04.04.2017																																																								
Bewerkt op	07.04.2017	Van (afkorting)	Kür																																																						
<table border="1" style="width: 100%; border-collapse: collapse;"> <tr> <td style="width: 10%;">02</td> <td style="width: 10%;">KIJER</td> <td style="width: 10%;">Datum</td> <td style="width: 10%;">07.04.2017</td> <td style="width: 10%;">Apparaat</td> <td style="width: 10%;">CFL22</td> <td style="width: 10%;">Titelblad/voorbeeld</td> <td style="width: 10%;">62-34-022-005</td> <td style="width: 10%;">EPLAN P8</td> <td style="width: 10%;">Art.Nr. 3063820_NL</td> <td style="width: 10%;">Blad</td> <td style="width: 10%;">1</td> </tr> <tr> <td></td> <td></td> <td>Bew.</td> <td>Kür</td> <td>E-register, KW</td> <td></td> <td></td> <td></td> <td>2.6.3</td> <td></td> <td>van</td> <td>16 Blad</td> </tr> <tr> <td></td> <td></td> <td>Gepr.</td> <td>herkomst</td> <td>Vervangen door</td> <td></td> <td></td> <td></td> <td></td> <td></td> <td></td> <td></td> </tr> <tr> <td></td> <td></td> <td>Datum</td> <td>Naam</td> <td>Vervangen door</td> <td></td> <td></td> <td></td> <td></td> <td></td> <td></td> <td></td> </tr> </table>										02	KIJER	Datum	07.04.2017	Apparaat	CFL22	Titelblad/voorbeeld	62-34-022-005	EPLAN P8	Art.Nr. 3063820_NL	Blad	1			Bew.	Kür	E-register, KW				2.6.3		van	16 Blad			Gepr.	herkomst	Vervangen door										Datum	Naam	Vervangen door							
02	KIJER	Datum	07.04.2017	Apparaat	CFL22	Titelblad/voorbeeld	62-34-022-005	EPLAN P8	Art.Nr. 3063820_NL	Blad	1																																														
		Bew.	Kür	E-register, KW				2.6.3		van	16 Blad																																														
		Gepr.	herkomst	Vervangen door																																																					
		Datum	Naam	Vervangen door																																																					

Kleuren bedrading:

- Primaire stroomkring : zwart
- Nulleider : lichtblauw
- Aardleiding : geel/groen
- Stuurkring voor wisselstroom : rood/ roodwit
- Stuurkring voor gelijkstroom : donkerblauw/ donkerblauw/wit
- Potentiaalvrij contact (parasitaire spanning) : oranje

OPGELET!!

Let vóór ingebruikname van de schakelkast op het volgende:

1. Alle aansluitingen dienen conform voorschriften van het plaatselijke elektriciteitsbedrijf te worden aangelegd
2. Alle verbindings- en contactschroeven, evenals de contacten die niet zijn toegewezen, moeten worden gecontroleerd op stevig vastzitten. (Door transport kunnen deze loslaten.)
3. De gebruikte motorbeveiligingsschakelaars voor de EC-ventilatoren en E-registers worden als leidingbeveiligingsschakelaars gebruikt, en moeten niet op de nominale stroom ingesteld worden..
4. Vergelijk de netspanning met de aansluitspanning van de schakelkast.
 - 5. Kabellengte voor voeler/servomotoren, 24 V-stuurkabels max. 50 m. Niet gelijkmatig plaatsen met 230/400 V-kabels of geïsoleerde kabels gebruiken
 - 6. Aangeboden kabeldiameters zijn minimum doorsneden voor koperen leidingen zonder de lengte van de kabel en de omstandigheden ter plaatse. Kabel types worden geselecteerd op basis van de routing.
 - 7. Om de vorstbescherming van de installatie te waarborgen is het niet toegestaan hoofdschakelaar Q1 uit te schakelen..
 - 8. Aardlekbeveiliging RCD Alleen voor alle stroomsoorten gevoelige FI-aardlekschakelaars type B met 300 mA toegelaten..

02	04.04.2017	KUER	Datum	07.04.2017	Apparaat	CFL22	AANWIJZINGEN INGEBRUIKNAME	62-34-022-005	=
			Bew.	Kur	E-register, KW				+
Wijziging	Datum	Naam	Gepr.	Herkomst	Vervangen door	Vervangen door		Afd.: TR	
				62-34-022-005				EP/JAN P8	
								2.6.3	
								Art.Nr. 3063820_NL	
									Blad
									van 16 Blad

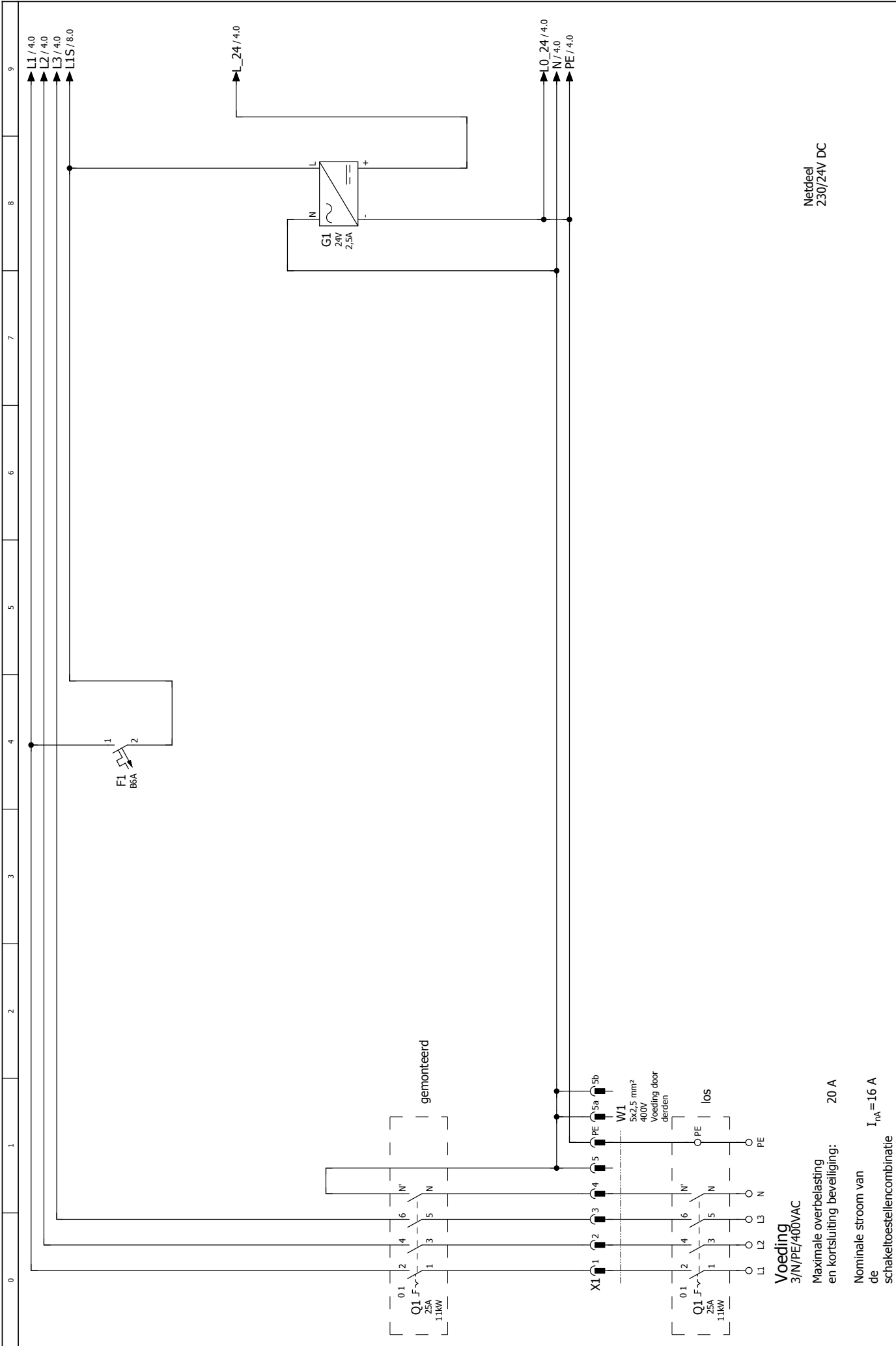

Netdeel
230/24V DC

Voeding
3/N/PE/400VAC
Maximale overbelasting en kortsluiting beveiliging: 20 A
Nominale stroom van de schakeltoestellencombinatie: $I_{nA} = 16 A$

02	04.04.2017	KUJER	Datum	04.04.2017	Apparaat	CFL22	E--register, KW	VOEDING	62-34-022-005	=	+
Wijziging			Datum					HOOFDSCHAKELAAR	Afd.: TR	EPLAN P8	3
					Vervangen door	Vervangen door		STUURTRAFO	2.6.3	Art.Nr. 3063820_NL	Blad
											van 16 Blad



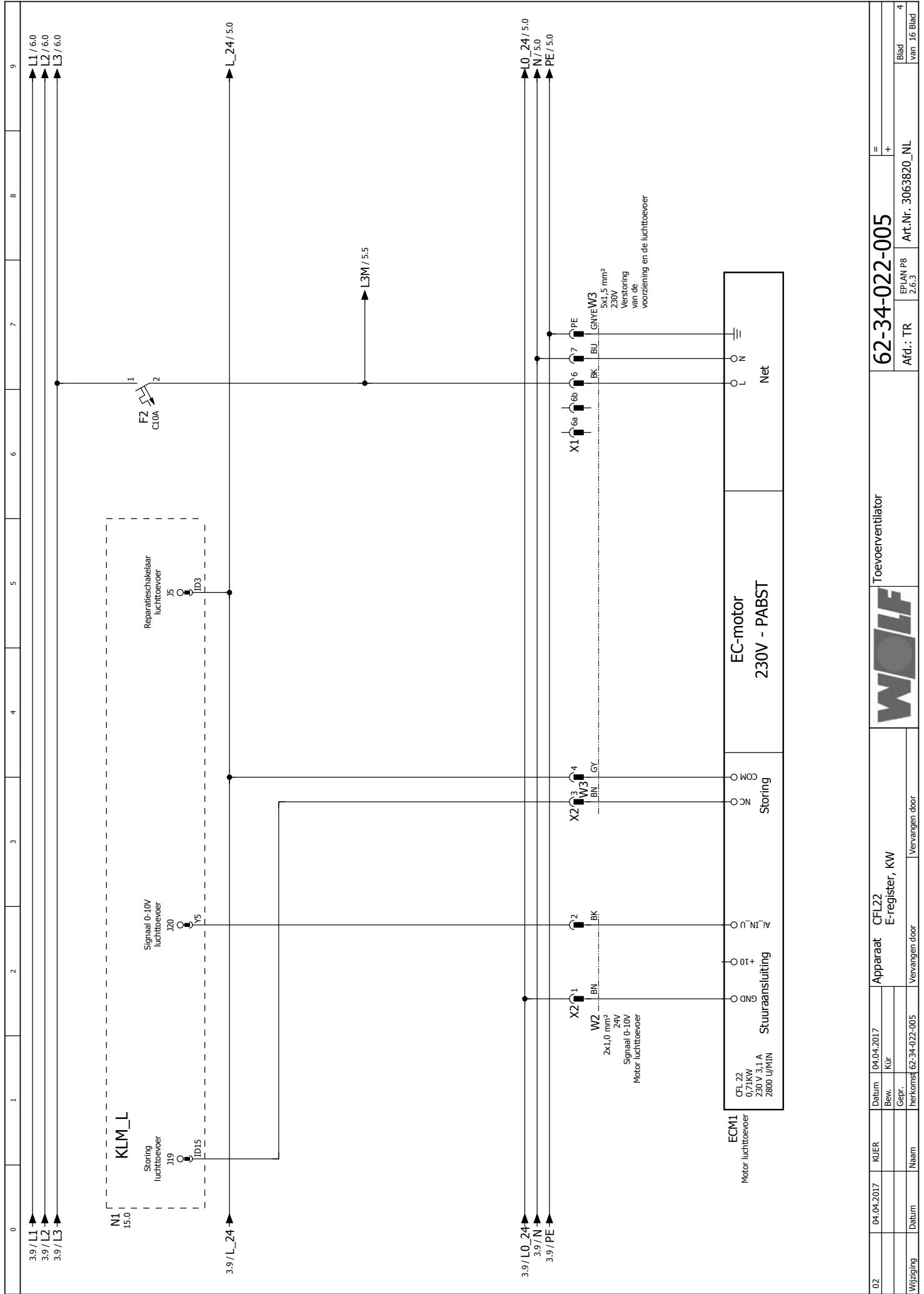

02	04.04.2017	KUER	Datum	04.04.2017	Bew.	Kur	Apparaat	CFL22 E-register, KW	ECM1 Motor lichttoevoer	EC-motor 230V - PABST	Toevoerventilator	62-34-022-005	=
			Gepr.									Afd.: TR	EP/JAN P8 2.6.3
												Art.-Nr. 3063820_NL	+
Wijziging	Datum	Naam	Herkomst	62-34-022-005	Vervangen door	Vervangen door							Blad van 16 Blad

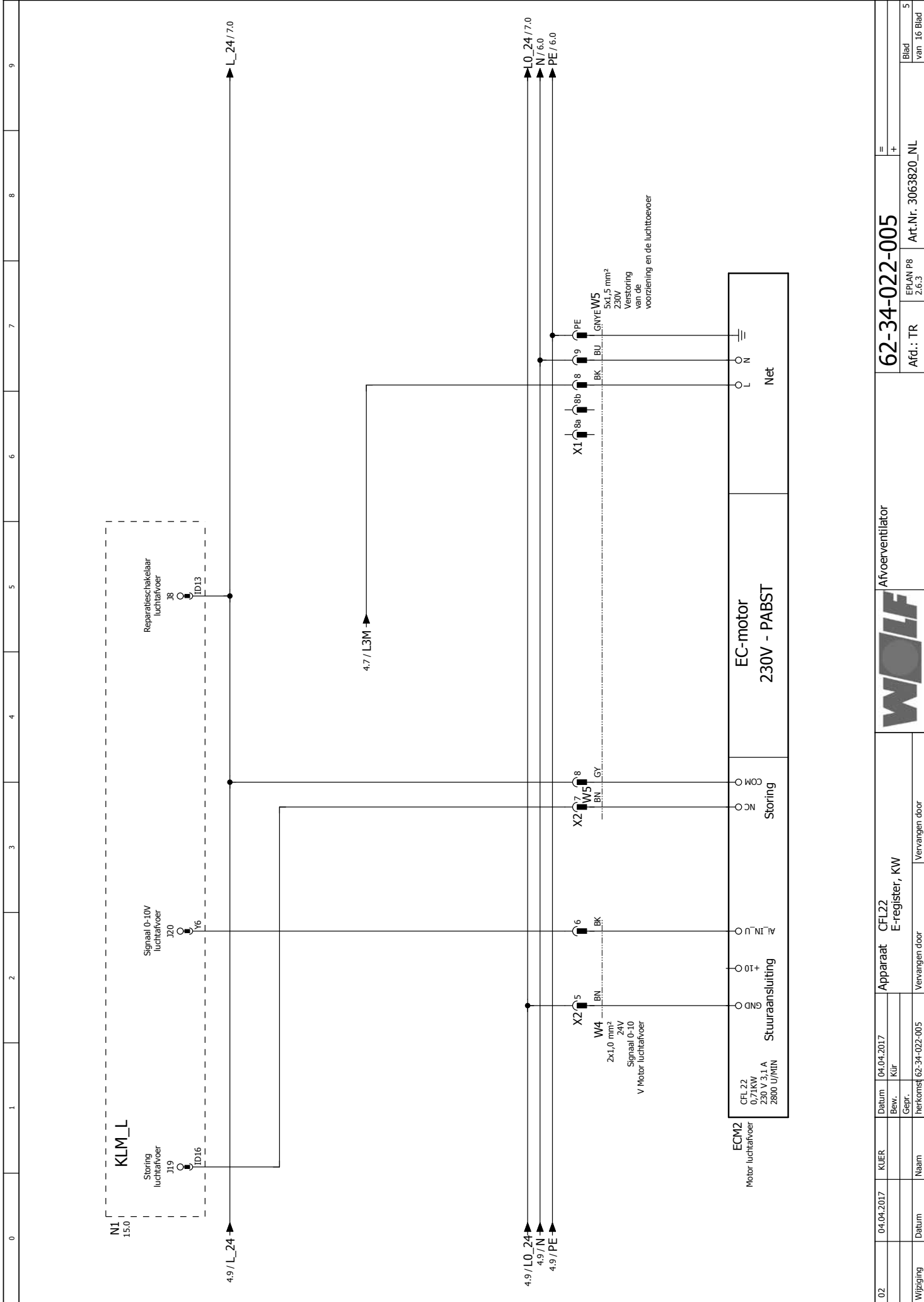

02	04.04.2017	KUJER	Datum	04.04.2017	Apparaat	CFL22	Afvoerventilator	62-34-022-005	=
			Bew.	Kür	E-register, KW				+
Wijziging	Datum	Naam	Gepr.	herkomst	Vervangen door		Vervangen door	Art.Nr. 3063820_NL	Blad
				62-34-022-005				2.6.3	van 16 Blad



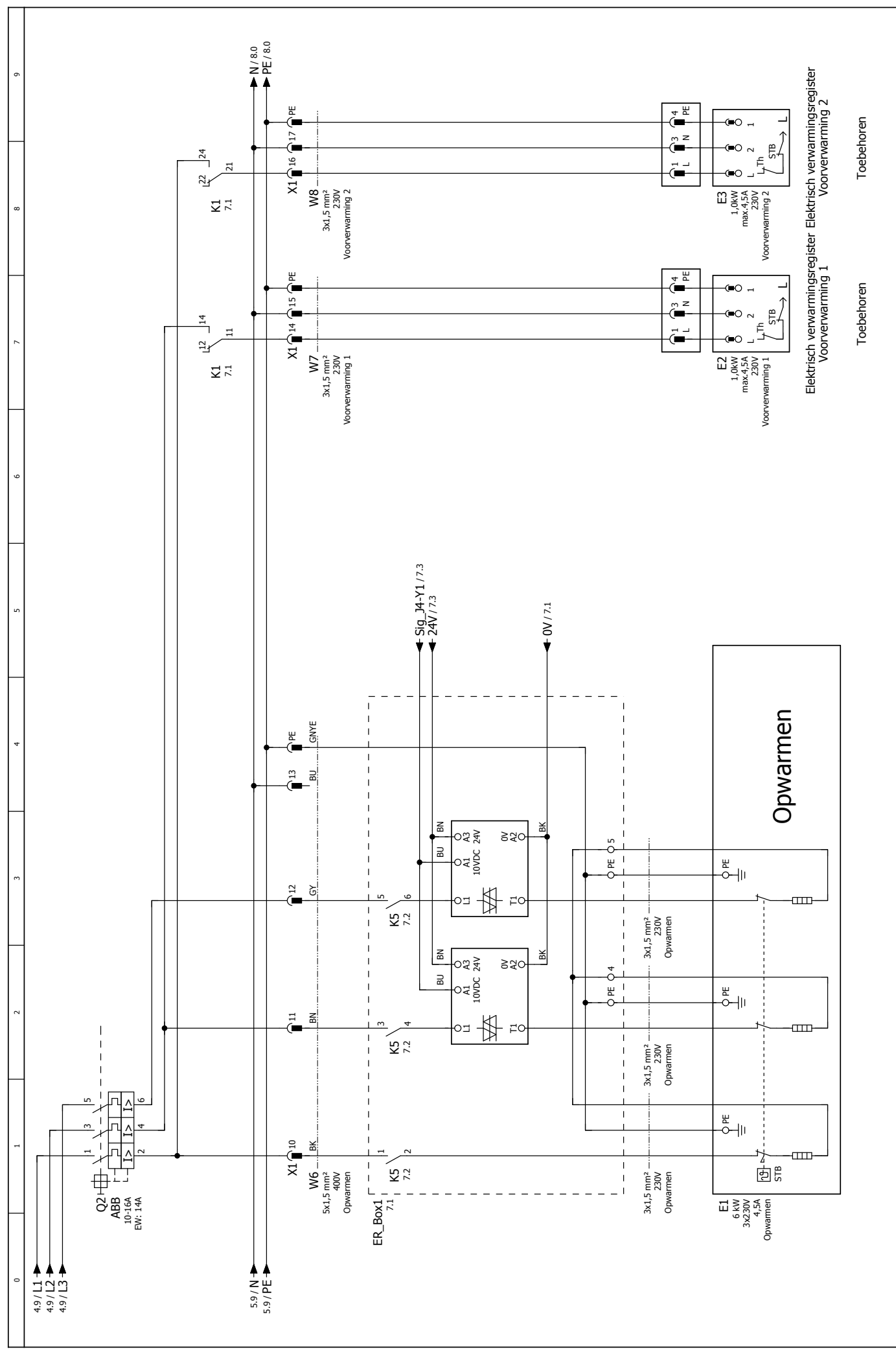

Elektrisch verwarmingsregister Elektrisch verwarmingsregister
Voorverwarming 1
Voorverwarming 2

Toebehoren

Toebehoren

02	04.04.2017	KUER	06.04.2017	Apparaat	CFL22																						
						E-register, KW																					
Wijziging	Datum	Naam	Herkomst	62-34-022-005	Vervangen door																						
					Vervangen door																						
				Apparaat				CFL22				BELASTINGSKRING				ELECTRISCH VERWARMINGSREGISTER				62-34-022-005							
				Datum				06.04.2017				EP/JAN P8				2.6.3				Art.Nr. 3063820_NL				=			
				Bew.				Kur																+			
				Gepr.																							
				Naam																							
				Datum																							
				Herkomst				62-34-022-005																			
				Vervangen door																							
				Vervangen door																							
				Datum																							
				Naam																							
				Herkomst																							
				Art.Nr.				3063820_NL																			
				Art.Nr.				3063820_NL																			
				Blad				van 16																			
				van 16																							



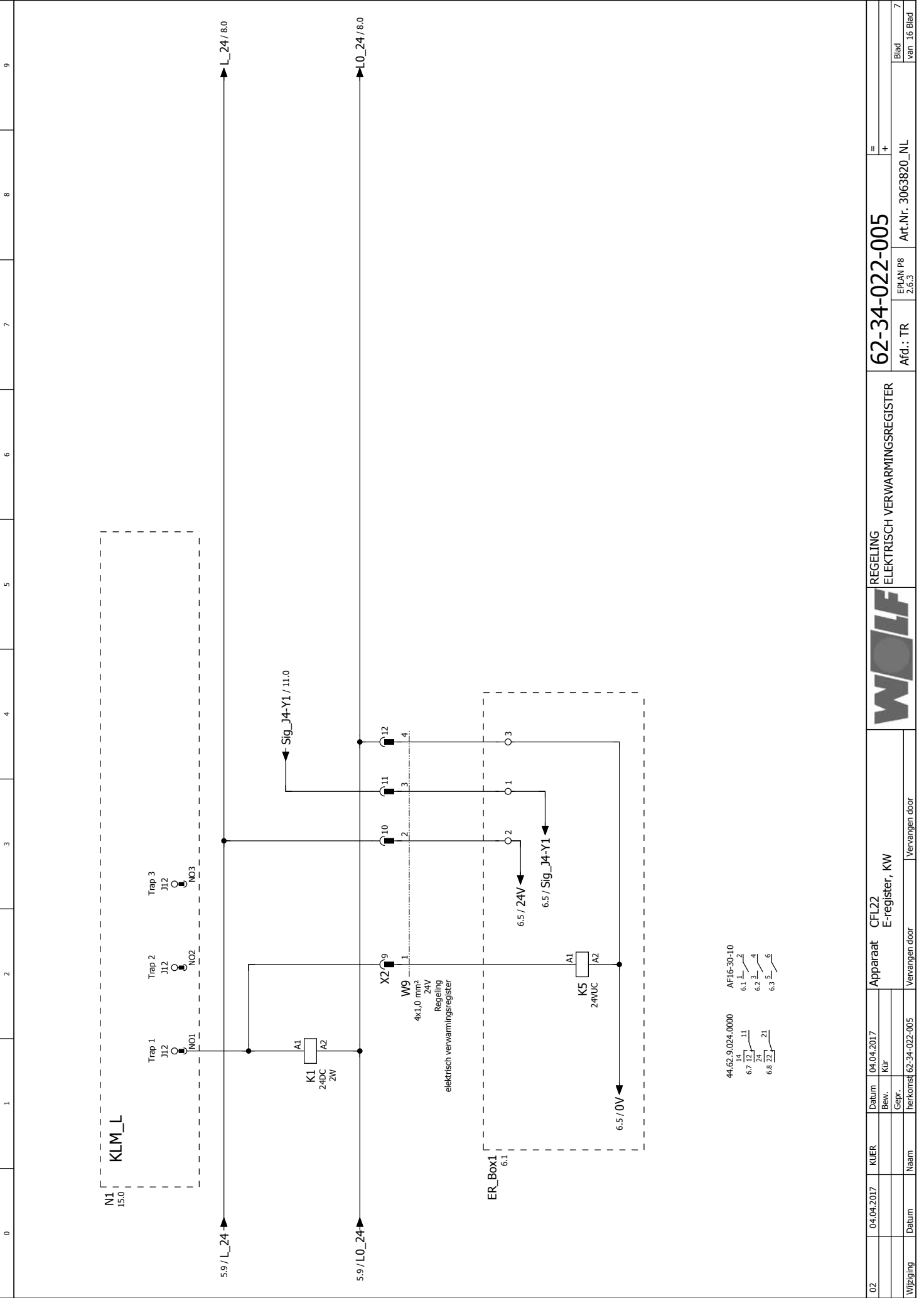

REGELING
ELEKTRISCH VERWARMINGSREGISTER

62-34-022-005

Afd.: TR EPLAN P8 2.6.3 Art.Nr. 3063820_NL

= +
Blad van 16 Blad 7

02	04.04.2017	KUJER	Datum	04.04.2017	Apparaat	CFL22 E-register, KW
			Bew.	Klir		
			Gepr.		Vervangen door	Vervangen door
Wijziging	Datum	Naam		herkomst	62-34-022-005	

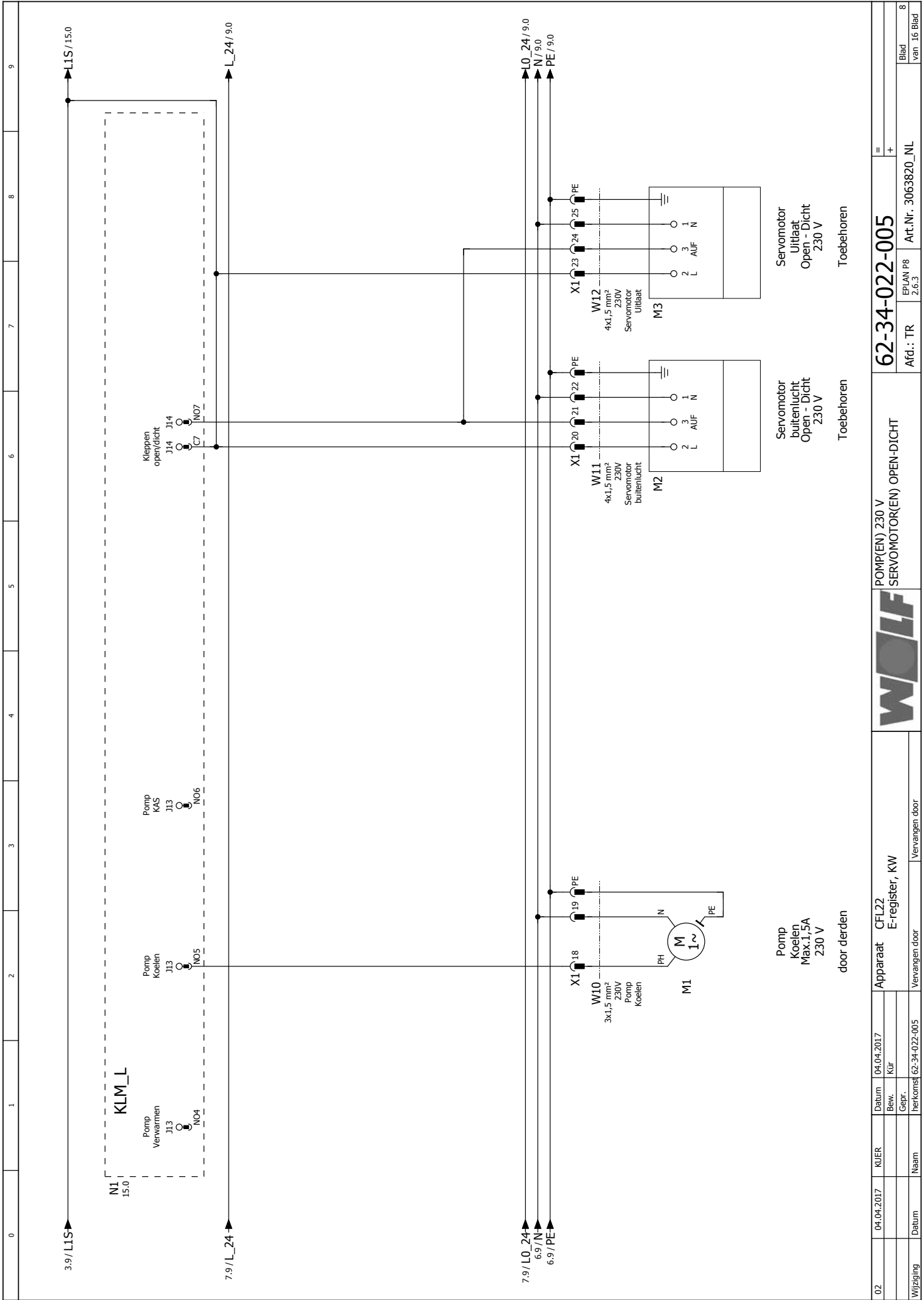

02	04.04.2017	KUER	Datum	04.04.2017	Apparaat	CFL22 E-register, KW	POMP(EN) 230 V SERVOMOTOR(EN) OPEN-DICHT	62-34-022-005	EP/JAN P8 2.6.3	Art.-Nr. 3063820_NL	= +
Wijziging	Datum	Naam	Gepr.	Herkomslij	Vervangen door	Vervangen door					
WOLF											
door derden											
Pomp Koelen Max.1,5A 230 V											
Servomotor buitenlicht 230 V											
Servomotor Uिताat 230 V											
Toebehooren											
Toebehooren											
Blad van 16 Blad											
8											

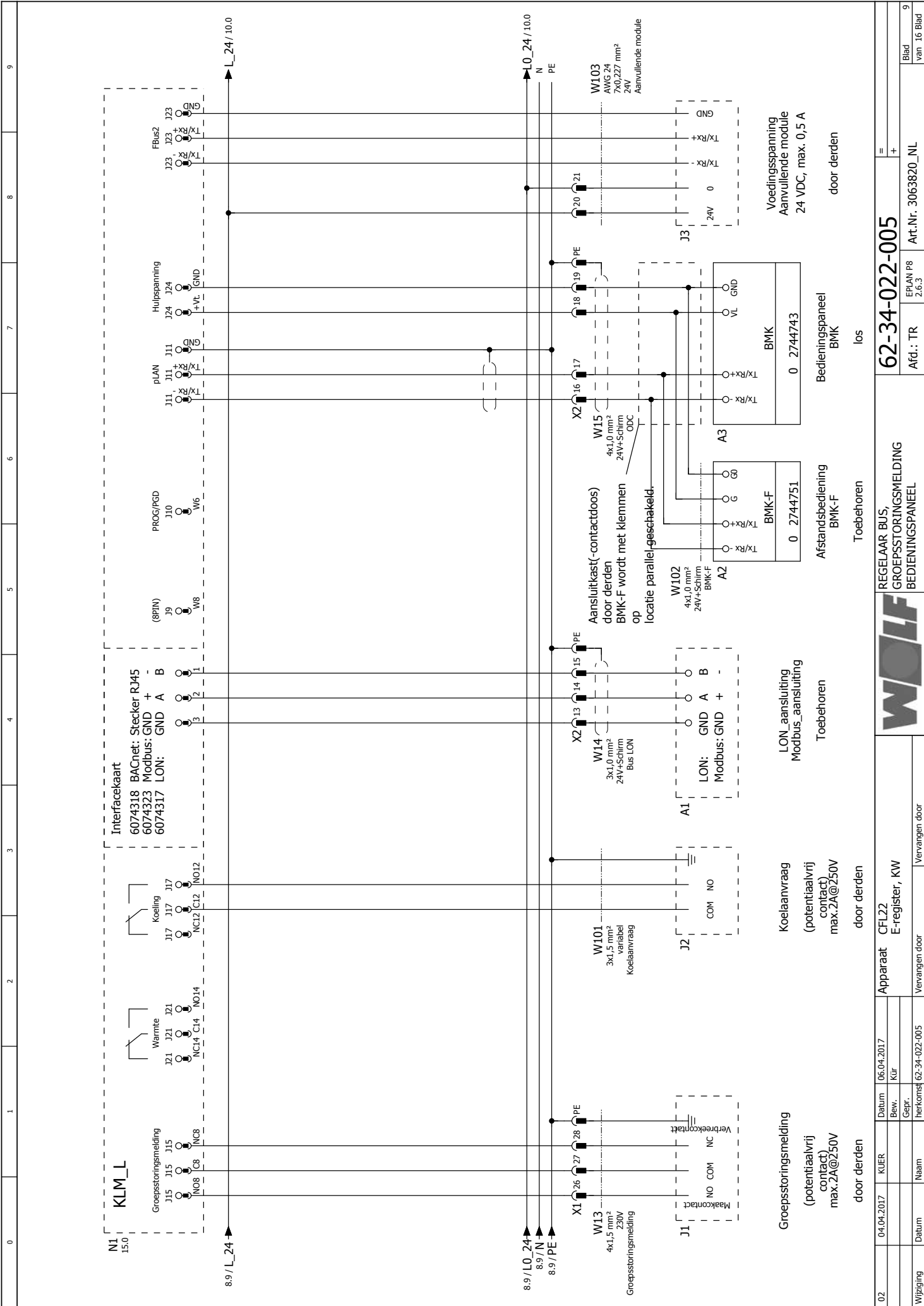

02	04.04.2017	KUJER	Datum	06.04.2017	Apparaat	CFL22	02	62-34-022-005	Art.Nr. 3063820_NL	Blad	9
			Bew.	Kijr	E-register, KW					van	16
			Gepr.	herkomst	Vervangen door						
					Vervangen door						

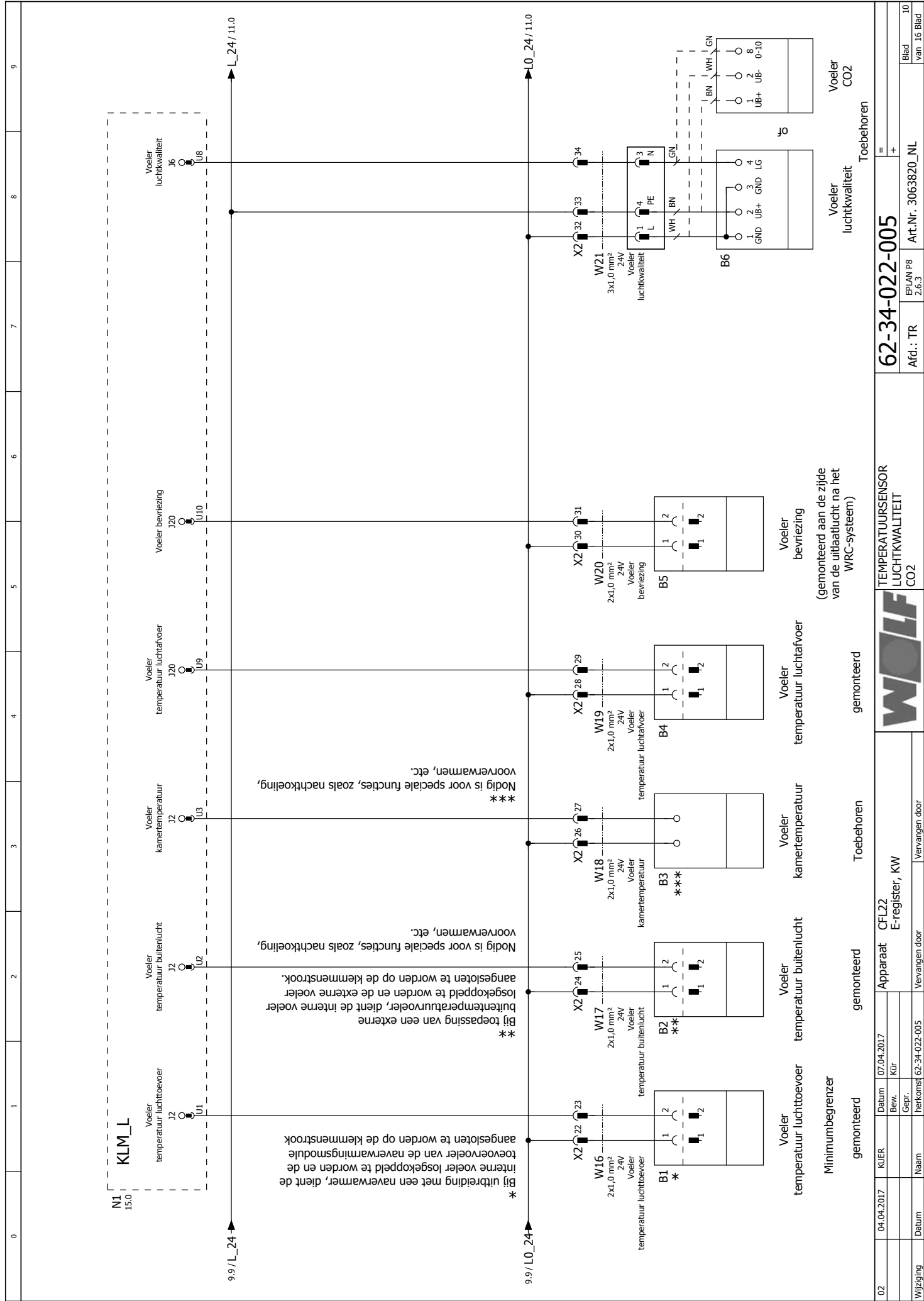

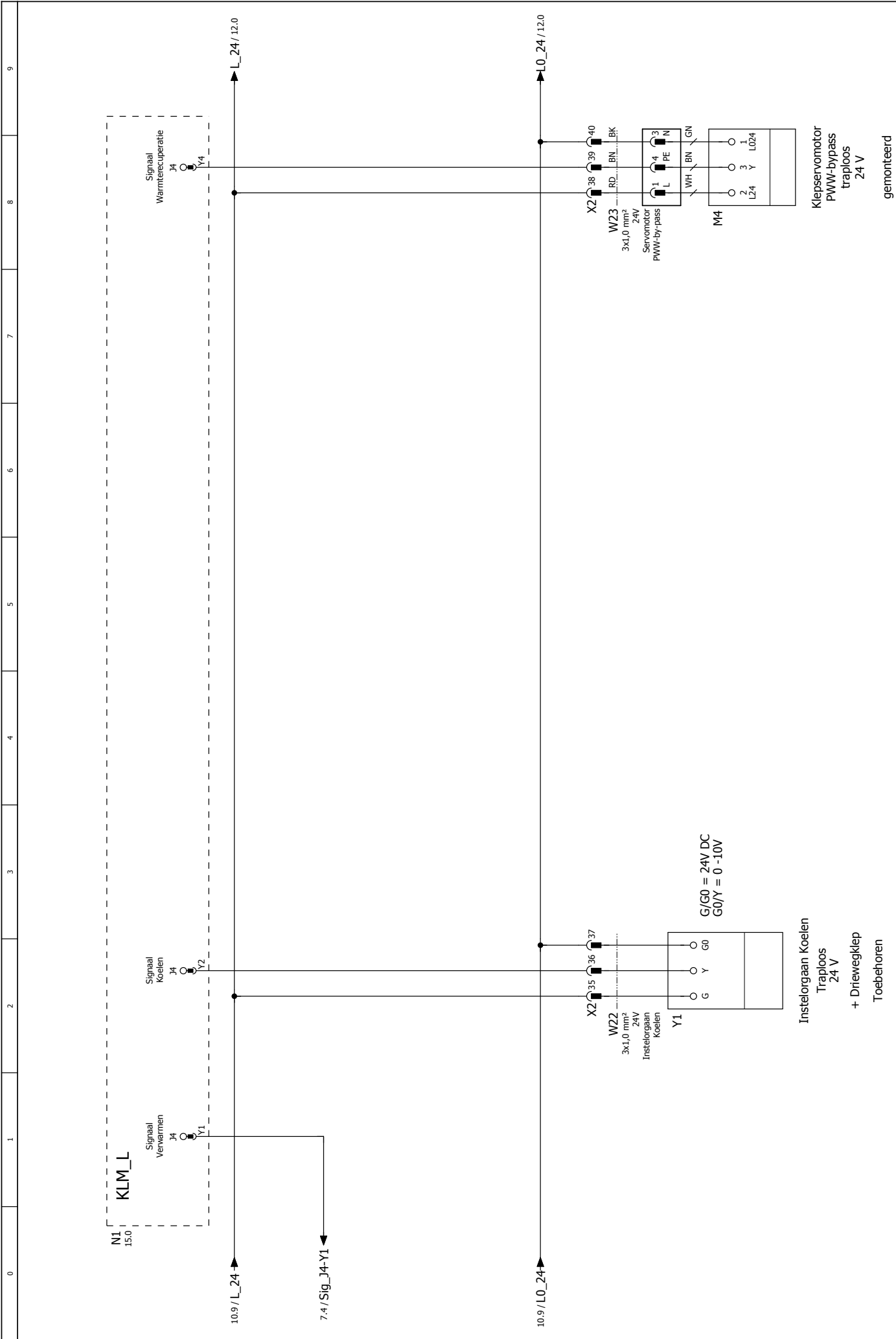

02	04.04.2017	KUJER	Datum	07.04.2017	Apparaat	CFL22	TRAPLOZE UITGANGEN	62-34-022-005	62-34-022-005	EPLAN P8	Art.Nr. 3063820_NL	Blad	11
			Bew.	Kür	E-register, KW					2.6.3		van	16
			Gepr.	herkomst	Vervangen door								Blad
					Vervangen door								van



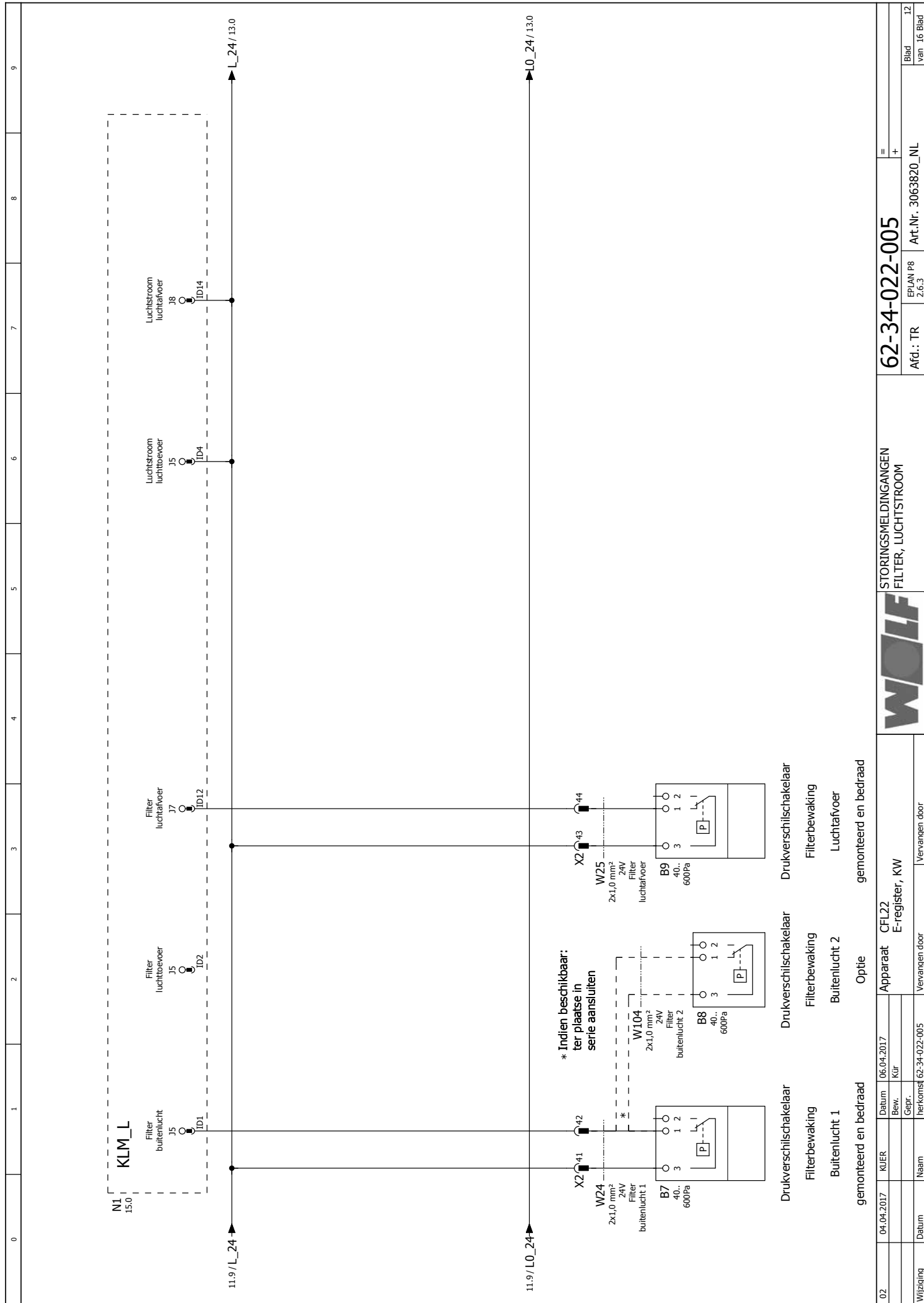

STORINGSMELDINGANGEN
FILTER, LUCHTSTROOM

62-34-022-005

Afd.: TR EP/JAN P8 2.6.3 Art.-Nr. 3063820_NL

Blad van 16 Blad

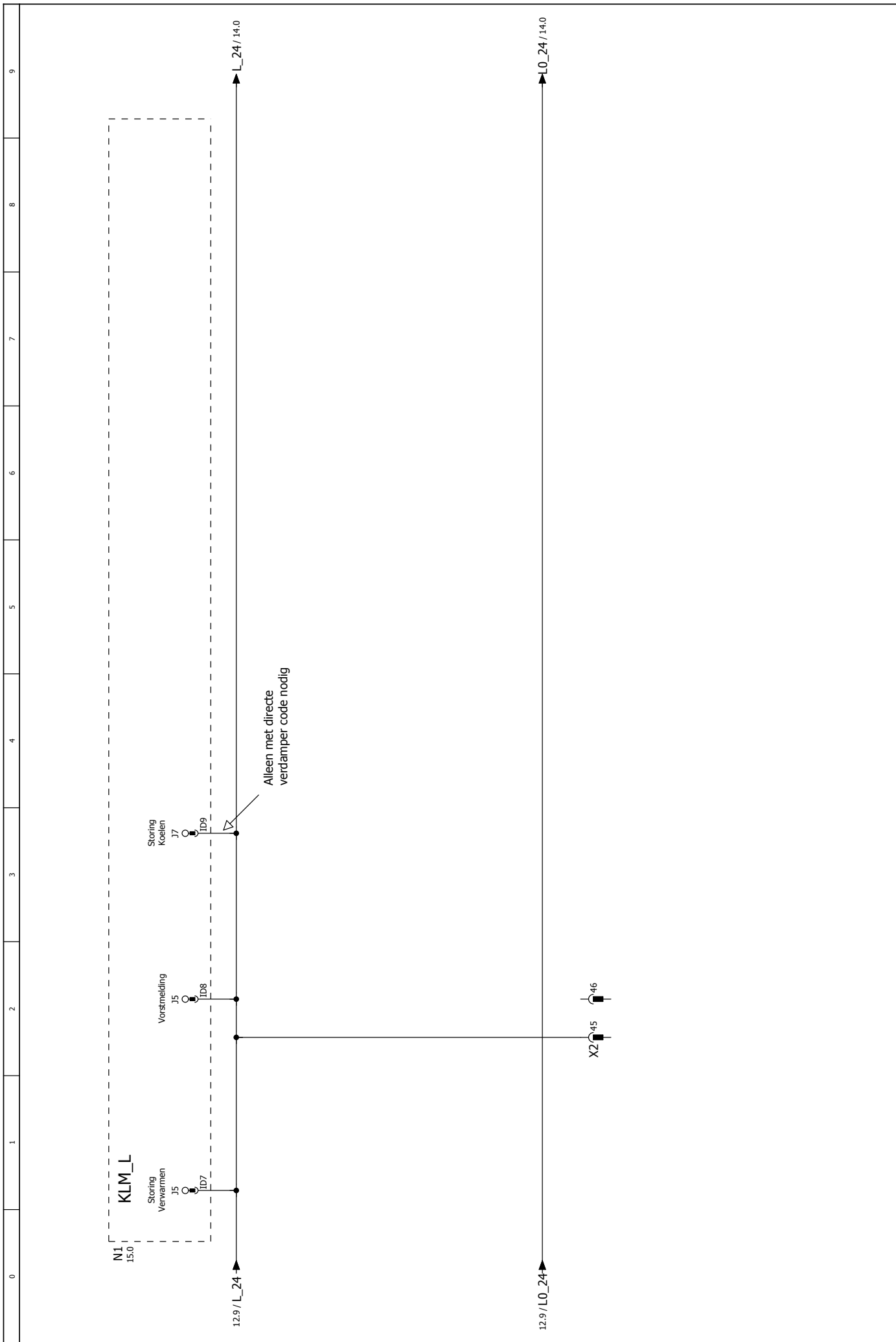

0	1	2	3	4	5	6	7	8	9
ONTYANGST STORINGSMELDINGEN VORST, KOUDE, WRC									
62-34-022-005									
= +									
Afd.: TR EPLAN P8 Art.Nr. 3063820_NL									
2.6.3 Blad van 16 Blad									
02	04.04.2017	KUJER	Datum	04.04.2017	Apparaat	CFL22			
			Bew.	Klir	E-register, KW				
			Gepr.	herkomst	62-34-022-005	Vervangen door			
Wijziging	Datum	Naam							
			Vervangen door						

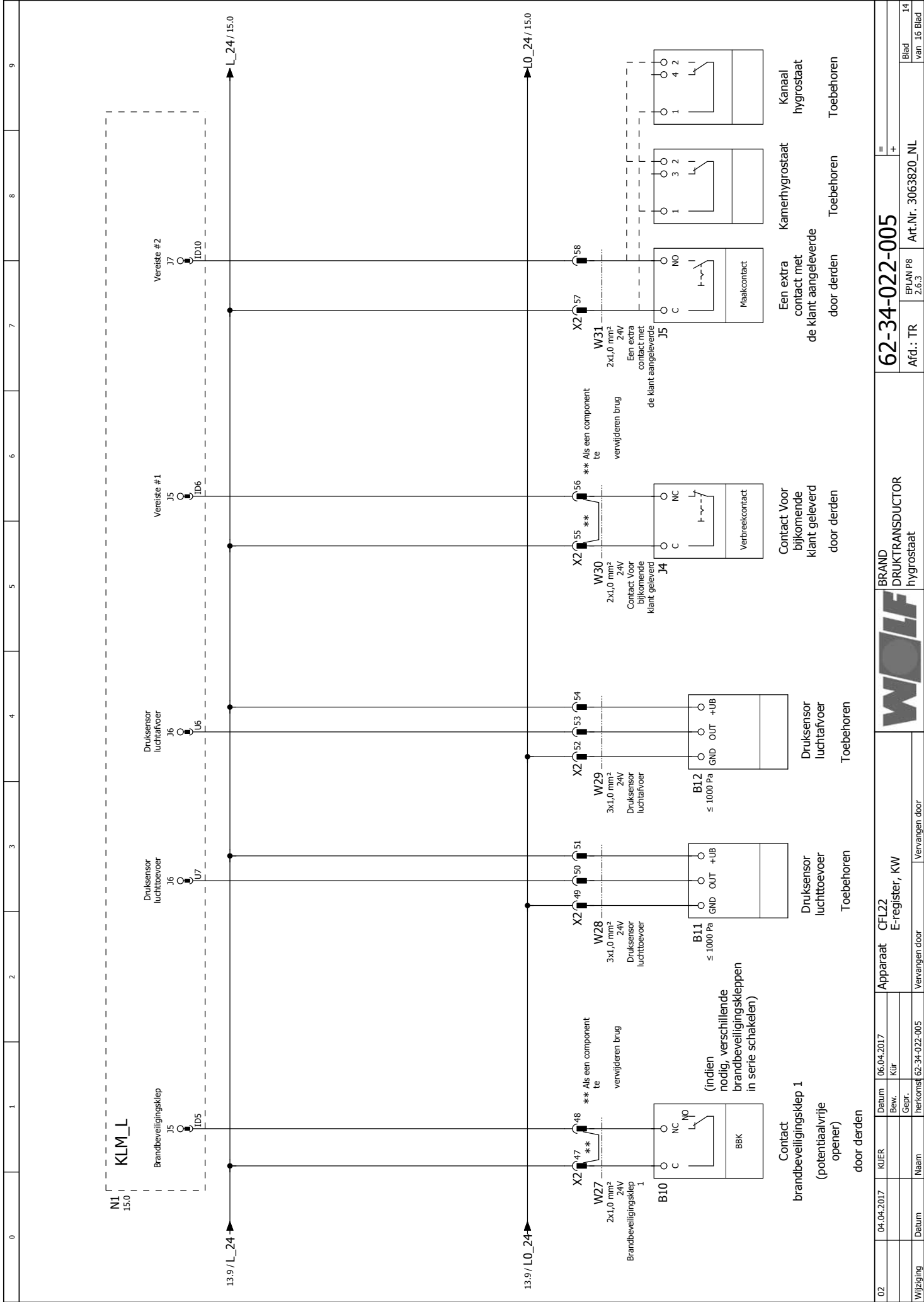

02	04.04.2017	KUER	Datum	06.04.2017	Datum	Apparaat	CFL22	BRAND	62-34-022-005	EP/JAN P8	62-34-022-005	62-34-022-005	62-34-022-005		
			Bew.	KUR	Bew.	E-register, KW		Druktransductor		2.6.3					
Wijziging	Datum	Naam	Gepr.	Gepr.	Gepr.	Vervangen door	Vervangen door	Vervangen door	Vervangen door	Art.Nr.	Art.Nr.	Art.Nr.	Art.Nr.	Art.Nr.	Art.Nr.
										3063820_NL	3063820_NL	3063820_NL	3063820_NL	3063820_NL	3063820_NL

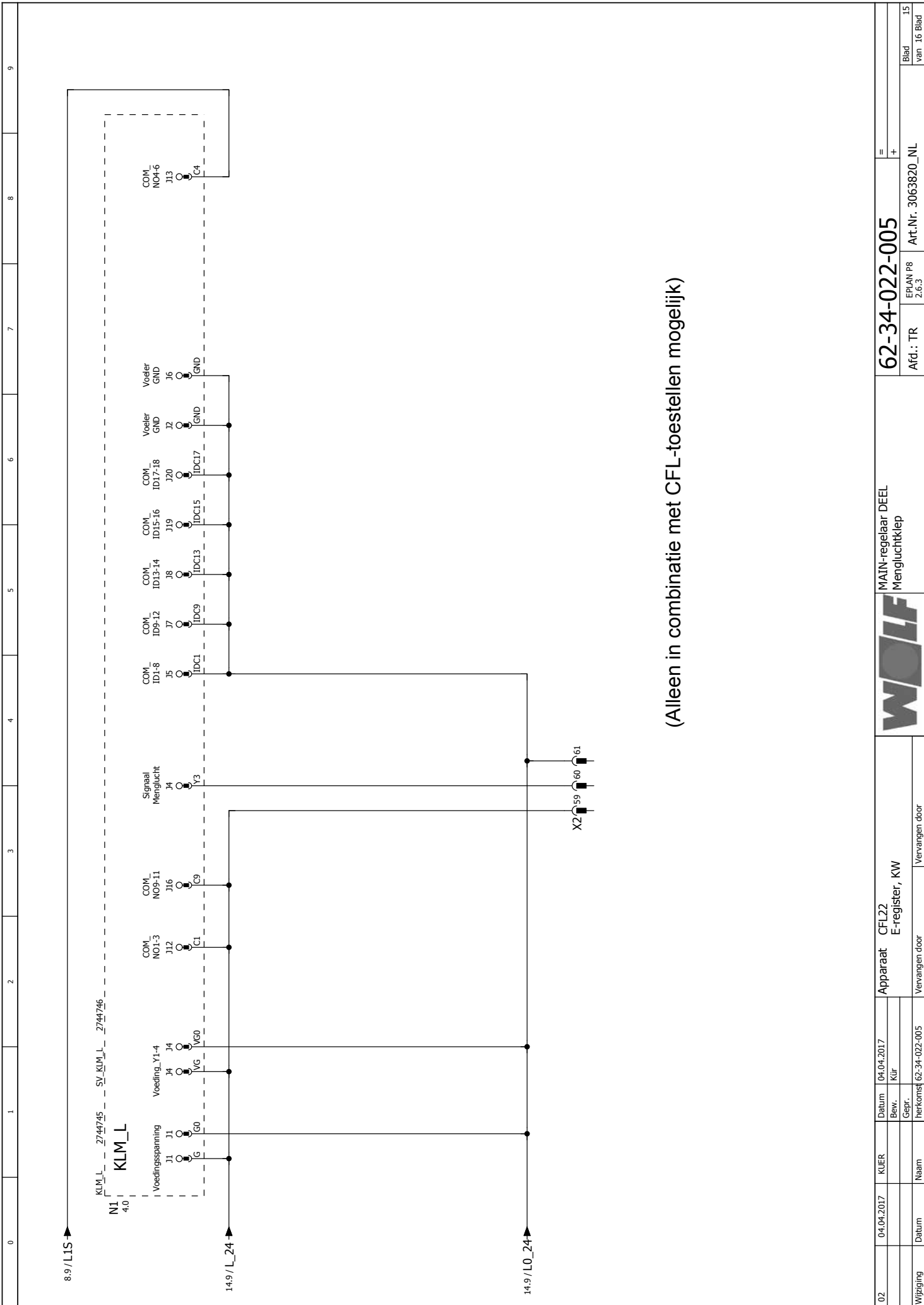

(Alleen in combinatie met CFL-toestellen mogelijk)

02	04.04.2017	KUJER	Datum	04.04.2017	Apparaat	CFL22 E-register, KW	 MAIN-regelaar DEEL Mengluchtklep	62-34-022-005	=	+
Wijziging	Datum	Naam	Gepr.	herkomst	Vervangen door	Vervangen door		Art.Nr. 3063820_NL		

