

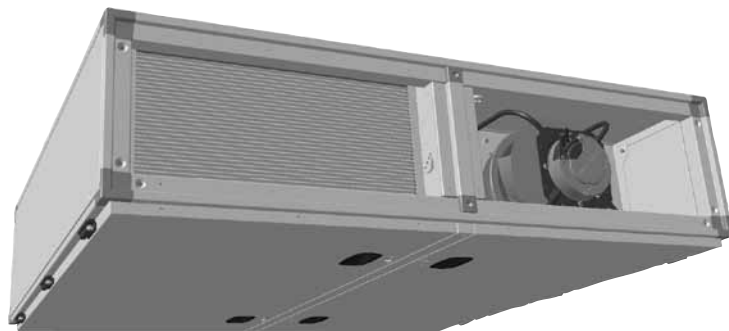





Schakelschema ventilatietoestel

CFL-10 Warmwaterregister



0	1	2	3	4	5	6	7	8	9		
									F26_001_Wolf_Standard		
					WOLF GmbH Industriestraße 1 D-84048 Mainburg Tel. +49 (0)8751 74-0						
					Elektrotechnische documentatie						
<hr style="border: 2px solid black;"/>											
Apparaat		CFL10 WW, KW									
Tekeningnummer		62-34-010-005									
Gemaakt op		02.04.2014									
Bewerkt op		03.11.2014									
		Van (afkorting)						KUER		Aantal pagina's 15	
Wijziging		Datum		Apparaat		Titelblad/voorbeeld				62-34-010-005	
		03.11.2014		CFL10						=	
		KUER		WW, KW						+	
Datum		Naam		Vervangen door		Vervangen door		Afd.: TR		EPLAN P8	
								2.0.5		Art.Nr. 3063785_NL	
										Blad	
										van 15 Blad	
										1	

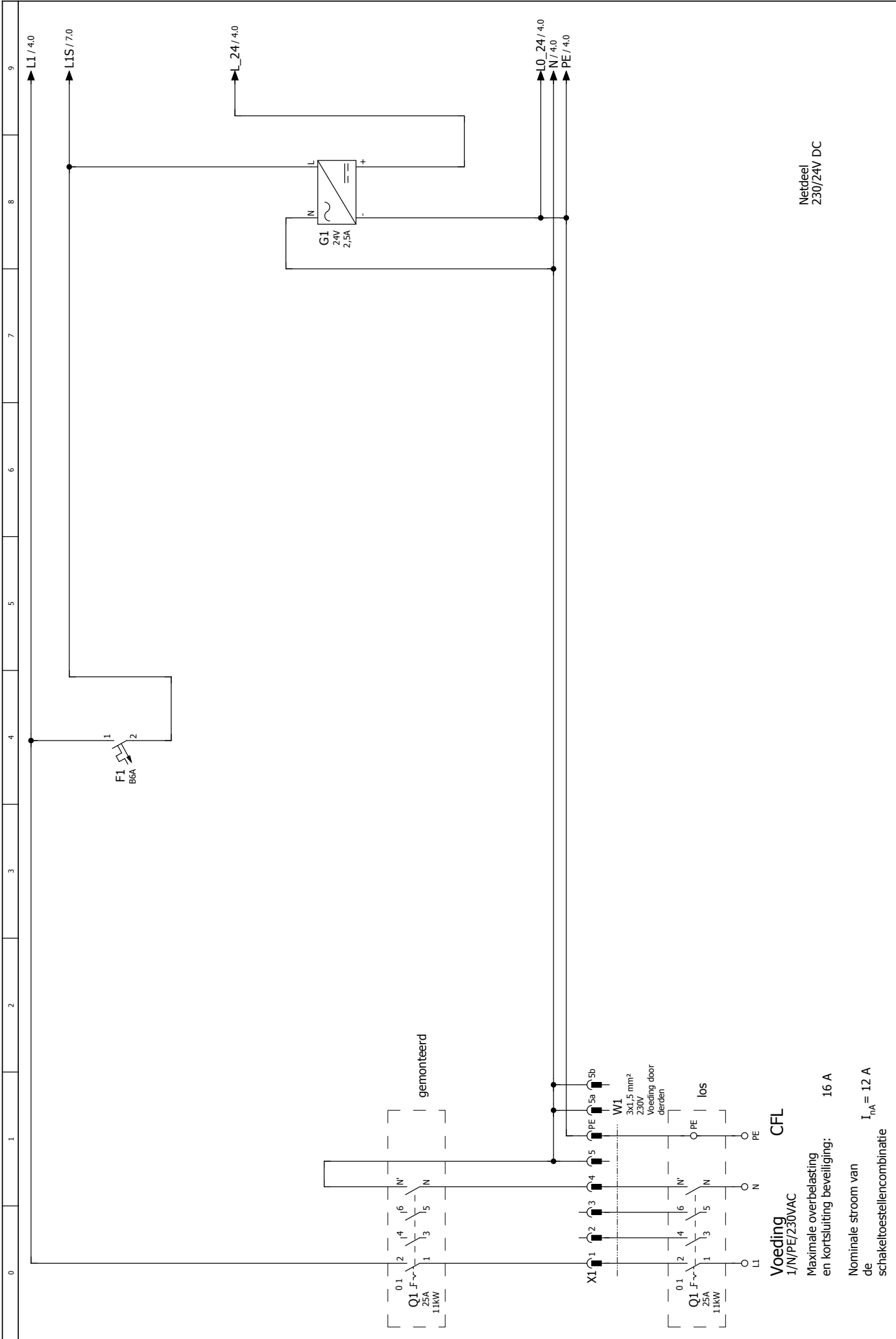

Netdeel
230/24V DC

62-34-010-005		VOEDING HOOFDSCHAKELAAR STUURTRAFO		EPLAN P8 2.0.5		Art.Nr. 3063785_NL		Blad van 15 Blad	
Apparaat		CFL10 WW, KW		Vervangen door		Vervangen door		Vervangen door	
Datum		18.09.2014		Datum		18.09.2014		Datum	
Bew.		KUER		Bew.		KUER		Bew.	
Gepr.		Gepr.		Gepr.		Gepr.		Gepr.	
Herkomst		Herkomst		Herkomst		Herkomst		Herkomst	
Naam		Naam		Naam		Naam		Naam	

Voeding
1/N/PE/230VAC
Maximale overbelasting
en kortsluiting beveiliging: 16 A
Nominale stroom van
de
schakeltoestellencombinatie
 $I_{nA} = 12 A$

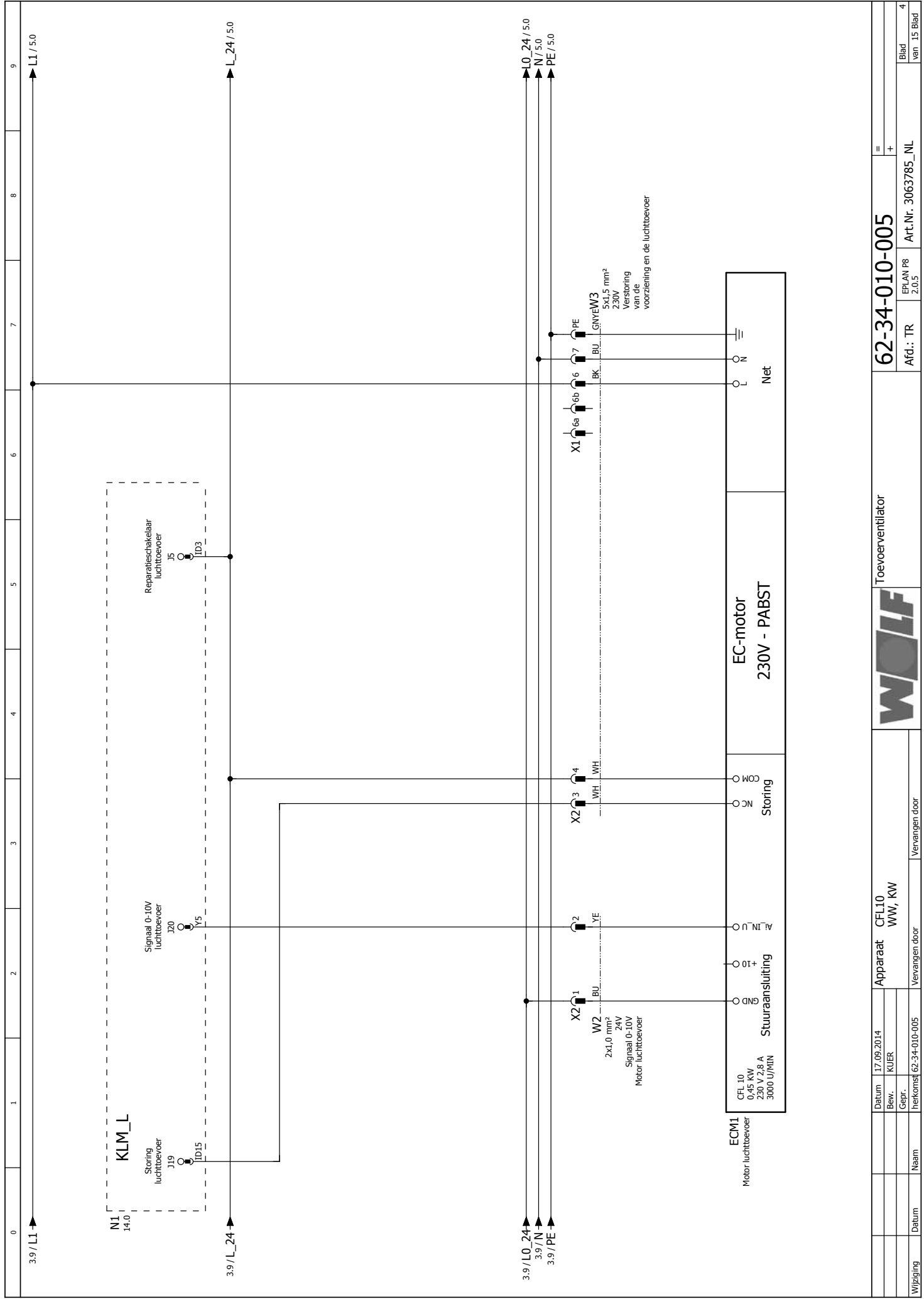

Wijziging	Datum	Naam	Rekenomsl 62-34-010-005	Vervangen door	Vervangen door		Toevoerventilator 62-34-010-005	Afd.: TR EPJAN P8 2.0.5 Art.Nr. 3063785_NL	=	Blad van 15 Blad
	Datum	Bew.	17.09.2014	Apparaat	CFL10 WW, KW				+	
	Gepr.	KLIER								

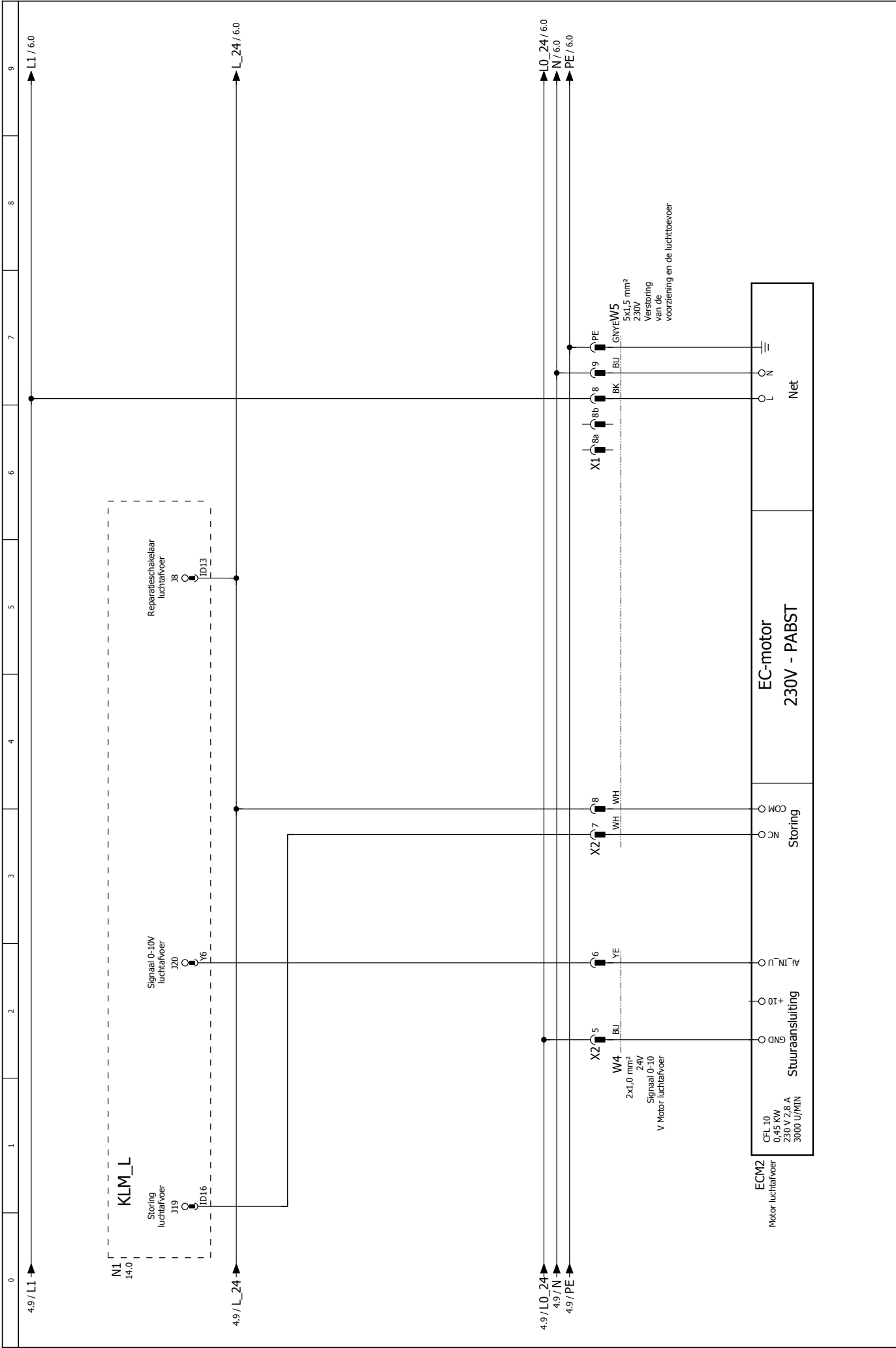

Datum		18.09.2014	Apparaat		CEL10	Afvoerventilator		62-34-010-005		=	
Bew.		KUER	Vervangen door		WW, KW	Afvoerventilator		EPLAN P8		+	
Gepr.			Vervangen door			Afvoerventilator		2.0.5		Art.Nr. 3063785_NL	
Naam			Vervangen door			Afvoerventilator		Afd.: TR		Blad	
Datum			Vervangen door			Afvoerventilator		2.0.5		van 15 Blad	
Wijziging			Vervangen door			Afvoerventilator		2.0.5		5	



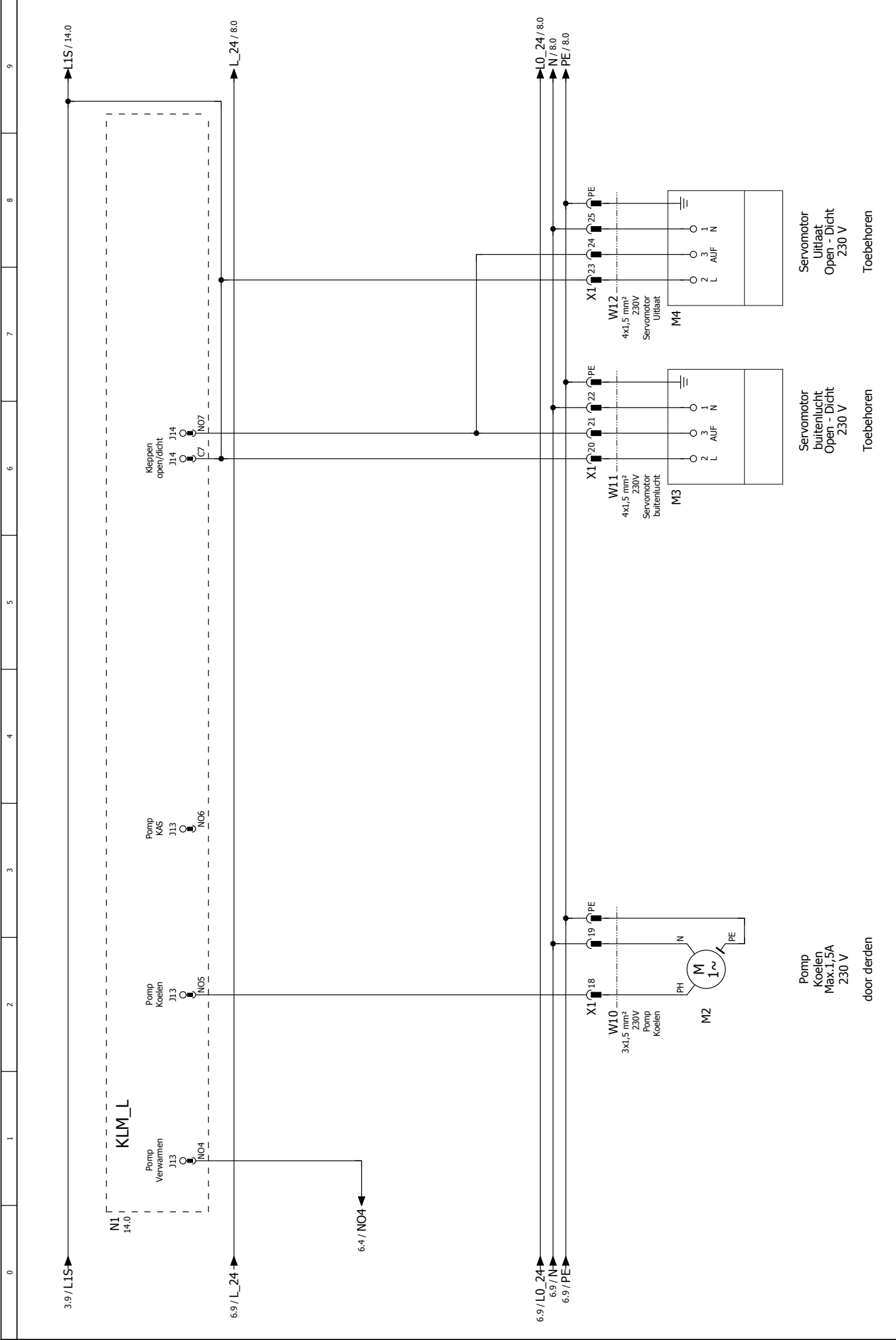

Wijziging	Datum	Naam	Vervangen door	Vervangen door
			Vervangen door	Vervangen door
	Datum	03.11.2014	Apparaat	CFL10
	Bew.	KUER	WW, KW	
	Gepr.			
	herkomst	62-34-010-005		
WOLF				
POMP(EN) 230 V SERVOMOTOR(EN) OPEN-DICHT				
62-34-010-005				
EPLAN P8 2.0.5				
Art.Nr. 3063785_NL				
= +				
				Blad
				van 15 Blad
				7

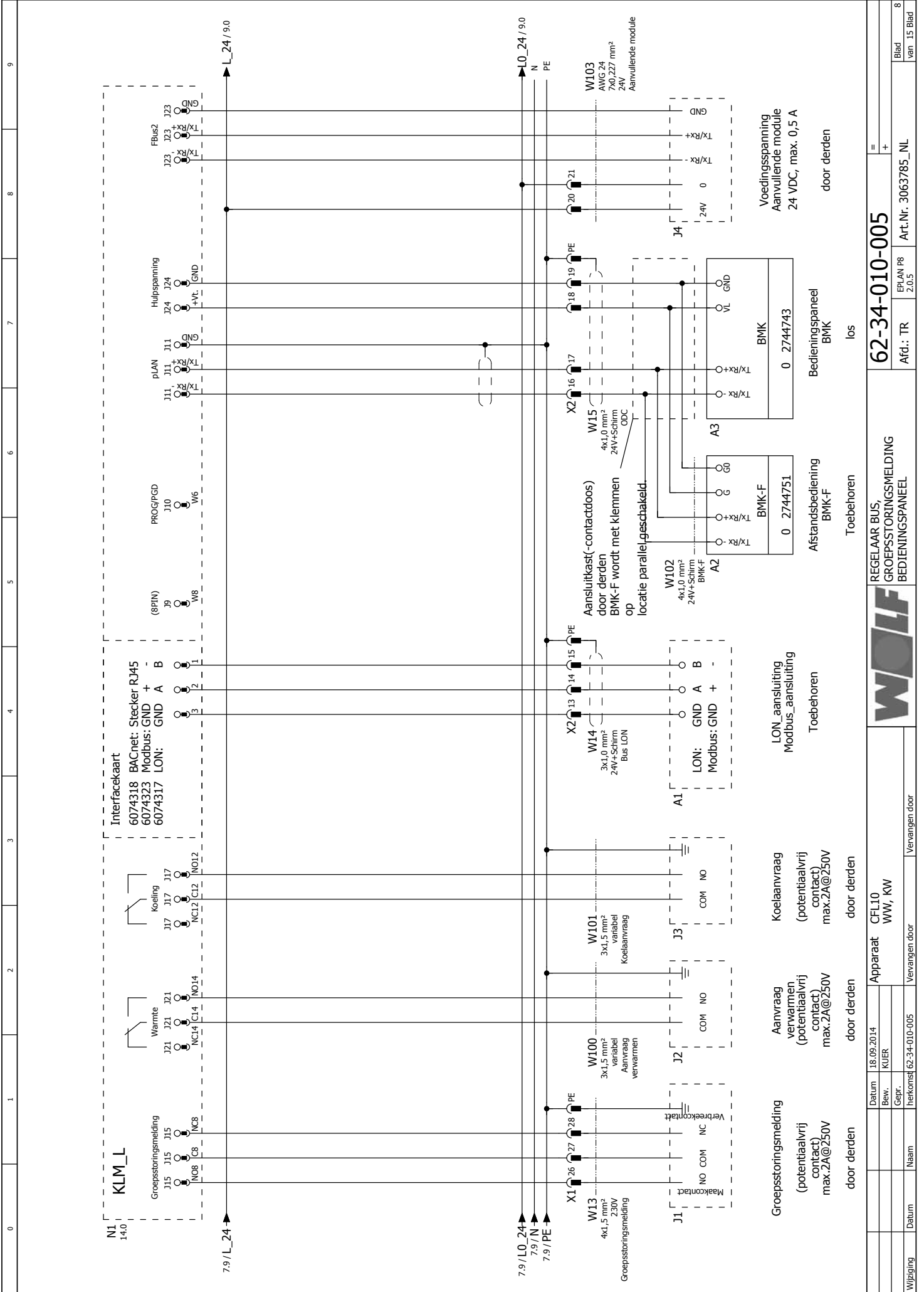

REGELAAR BUS, GROEPSSTORINGSMELDING, BEDIENINGSPANEEL

62-34-010-005

Afd.: TR, EPJAN P8 2.0.5, Art.Nr. 3063785_NL

Blad 8 van 15 Blad

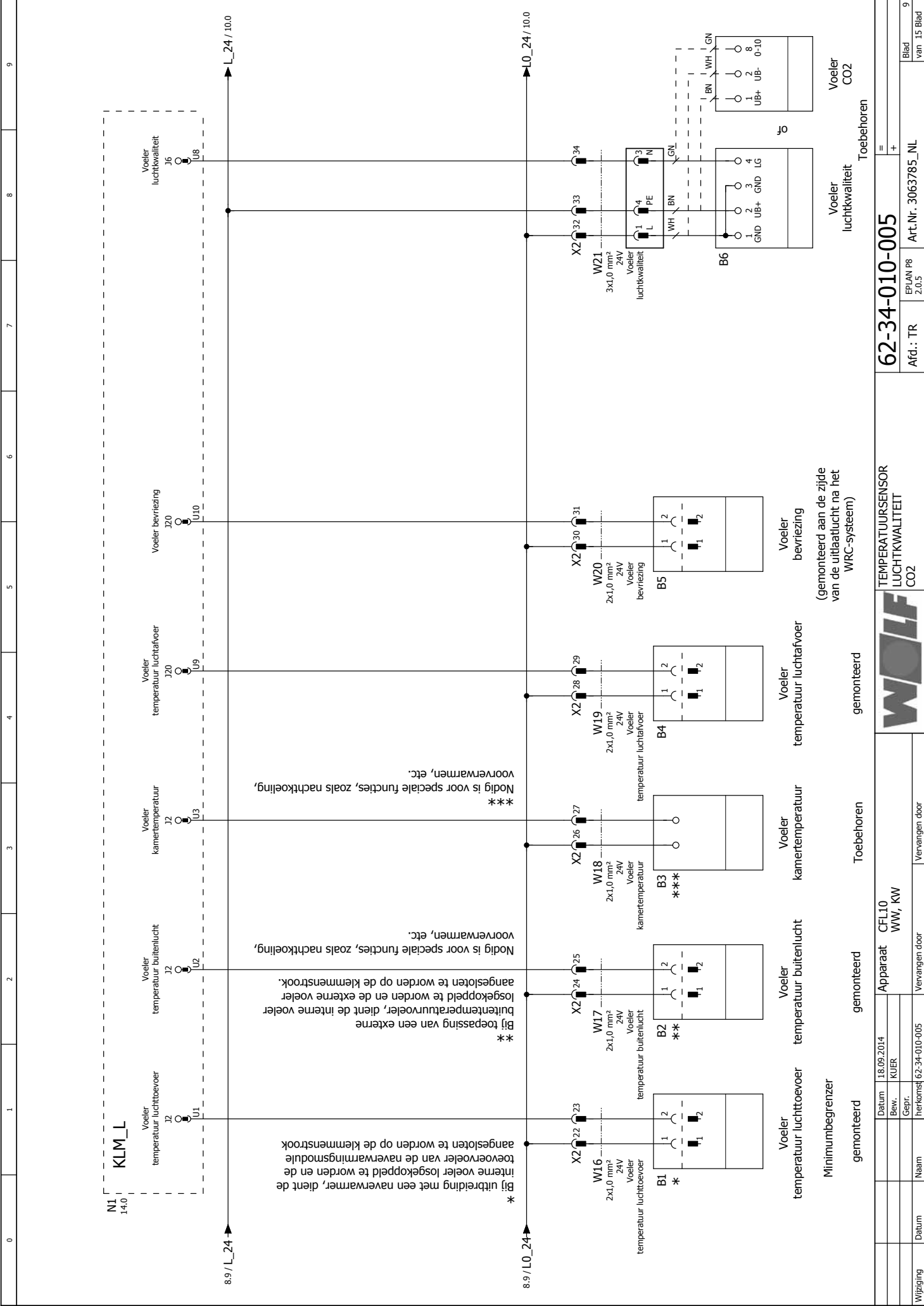

62-34-010-005		TEMPERATUURSSENSOR LUCHTKWALITEIT CO2	
Afd.: TR	EPLAN P8 2.0.5	Art.Nr. 3063785_NL	Blad van 15 Blad 9
WOLF		TOEBEHOREN	
Apparaat CFL10 WW, KW		Minimumbegrenzer	
Datum	18.09.2014	Datum	18.09.2014
Bew.	KUER	Bew.	KUER
Gepr.	62-34-010-005	Gepr.	62-34-010-005
Naam	Vervangen door	Naam	Vervangen door
gemonteerd		gemonteerd	
Toebehooren		Toebehooren	
gemonteerd		gemonteerd	
Voeler kamertemperatuur		Voeler kamertemperatuur	
Voeler temperatuur buitenlicht		Voeler temperatuur buitenlicht	
Voeler temperatuur luchttafvoer		Voeler temperatuur luchttafvoer	
Voeler bevoorziening		Voeler bevoorziening	
Voeler luchtkwaliteit		Voeler luchtkwaliteit	
Voeler CO2		Voeler CO2	

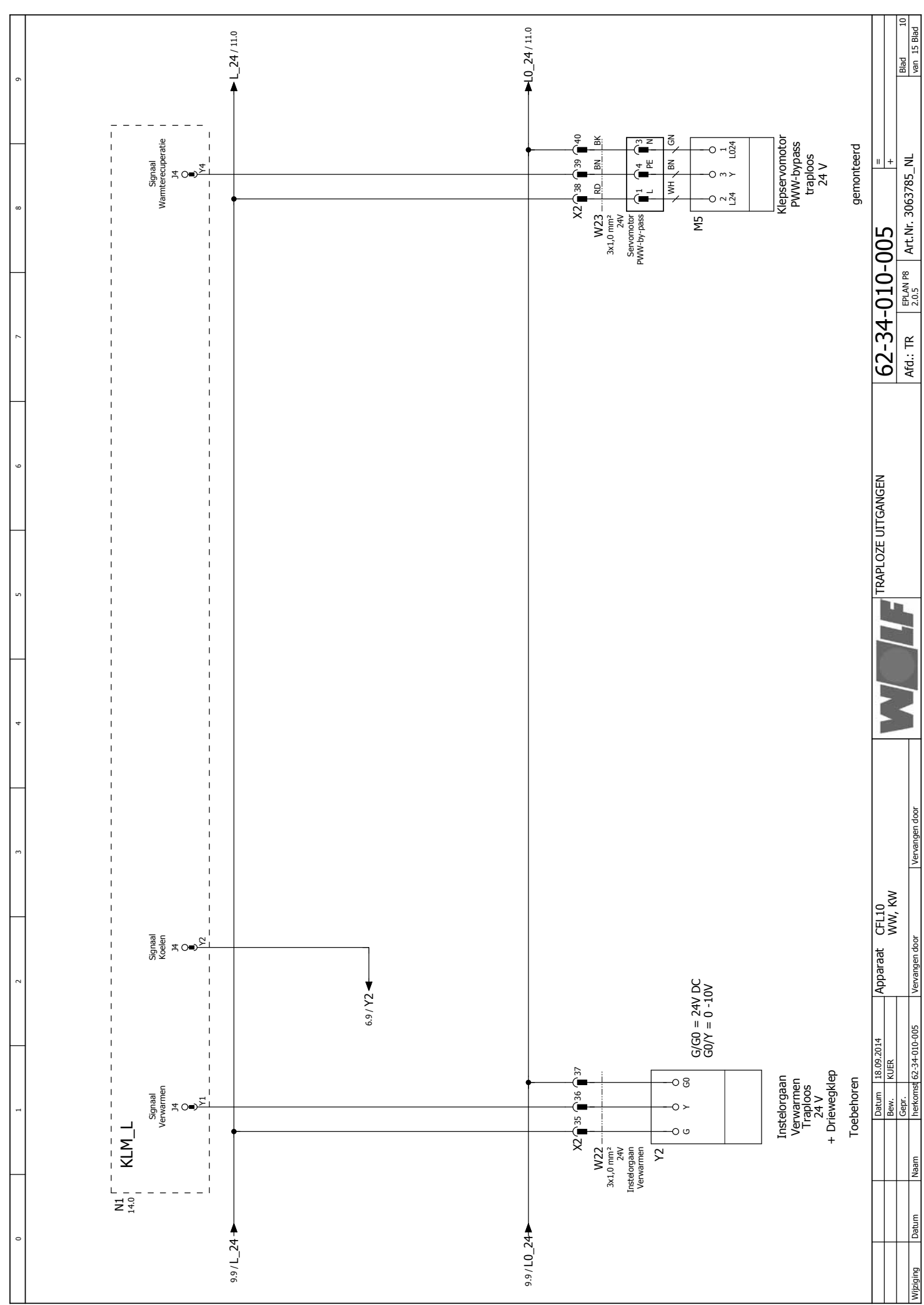

0	1	2	3	4	5	6	7	8	9
<p>WOLF</p> <p>TRAPLOZE UITGANGEN</p> <p>62-34-010-005</p> <p>Art.Nr. 3063785_NL</p> <p>EPJAN P8 2.0.5</p> <p>Afd.: TR</p> <p>Blad van 15 Blad</p>									
<p>Apparaat: CFL10 WW, KW</p> <p>Datum: 18.09.2014</p> <p>Bew.: KLIJER</p> <p>Gepr.: []</p> <p>Thetkomsj: 62-34-010-005</p> <p>Vervangen door: []</p> <p>Vervangen door: []</p> <p>Instelorgaan Verwarmen Traploos 24 V + Driewegklep Toebehoren</p> <p>Instelorgaan Verwarmen Traploos 24 V + Driewegklep Toebehoren</p> <p>G/G0 = 24V DC G0/Y = 0 -10V</p> <p>6.9 / Y2</p> <p>9.9 / L_24</p> <p>9.9 / L0_24</p> <p>L_24 / 11.0</p> <p>L0_24 / 11.0</p> <p>W22 3x1,0 mm² 24V Instelorgaan Verwarmen Y2</p> <p>W23 3x1,0 mm² 24V Servomotor PWM-by-pass L PE N</p> <p>M5 2 3 1 L24 Y L024</p> <p>Klepservomotor PWM-by-pass traploos 24 V</p> <p>gemonnteerd</p>									

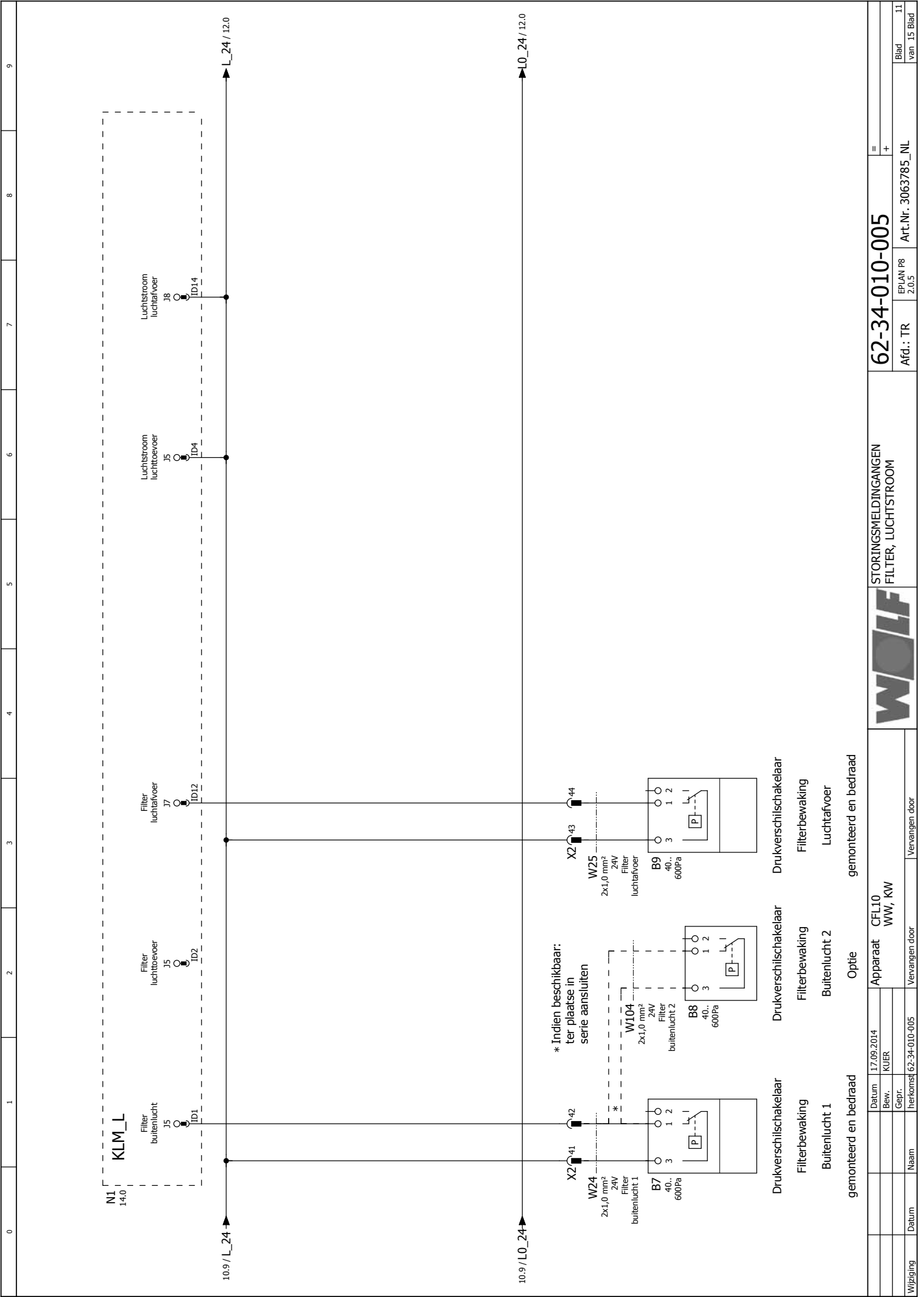

Wijziging		Datum	Naam	Datum	Apparaat	CFL10 WW, KW	Vervangen door	
				17.09.2014			Vervangen door	
		Bew.	KUER					
		Gepr.						
		herkomst	62-34-010-005					
STORINGSMELDINGANGEN FILTER, LUCHTSTROOM							62-34-010-005	
EPLAN P8 2.0.5							Art.Nr. 3063785_NL	
Afd.: TR							=	
							+	
							Blad van 15 Blad	
							11	



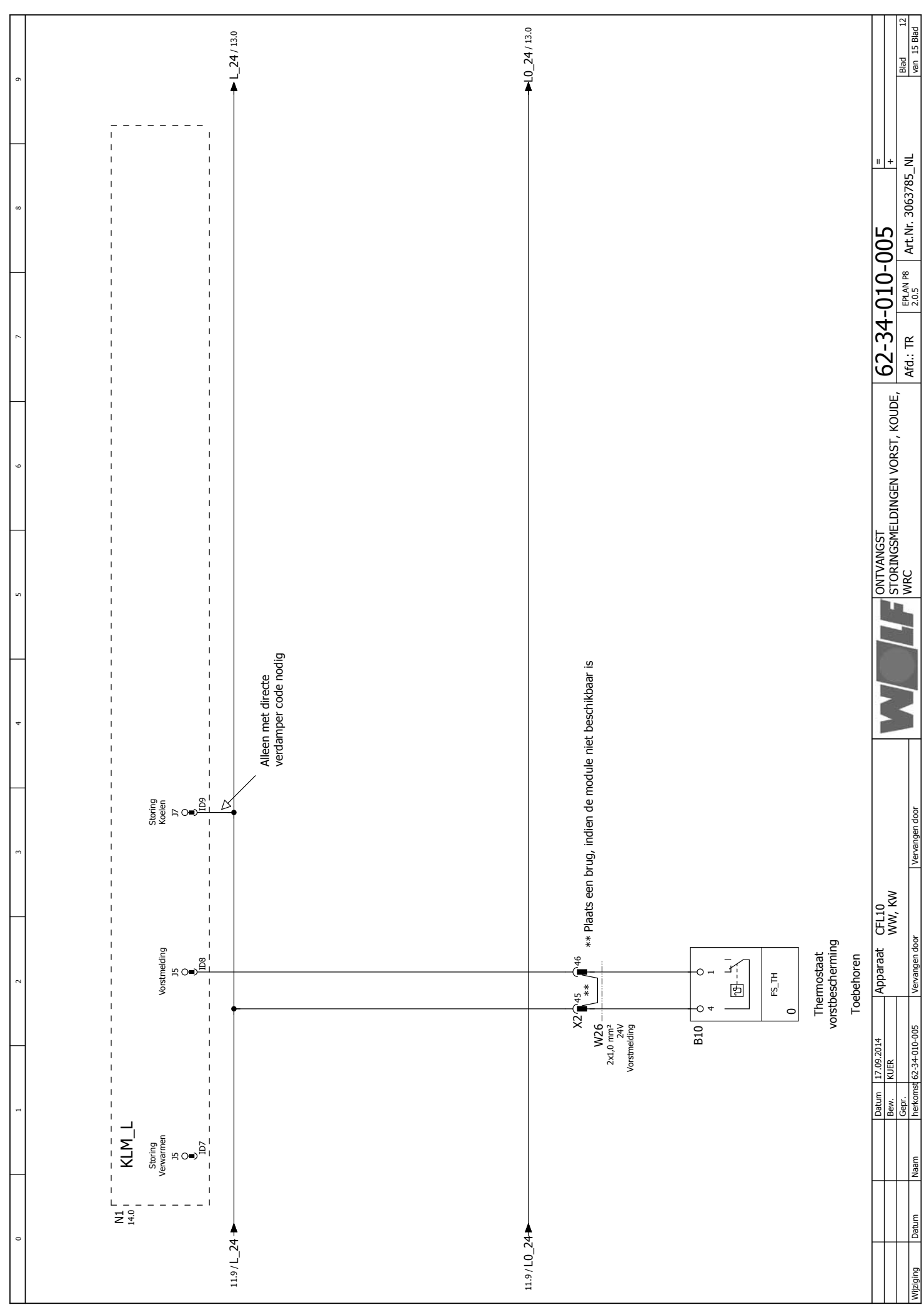

Wijziging	Datum	Naam	Gepr.	Bew.	Datum	Apparaat	CFL10 WW, KW	ONTVANGST STORINGSMELDINGEN VORST, KOUDE, WRC	62-34-010-005	= +
				KLIJER	17.09.2014	Vervangen door	Vervangen door		Afd.: TR	EPJAN P8 2.0.5
									Art.-Nr. 3063785_NL	
										Blad van 15 Blad



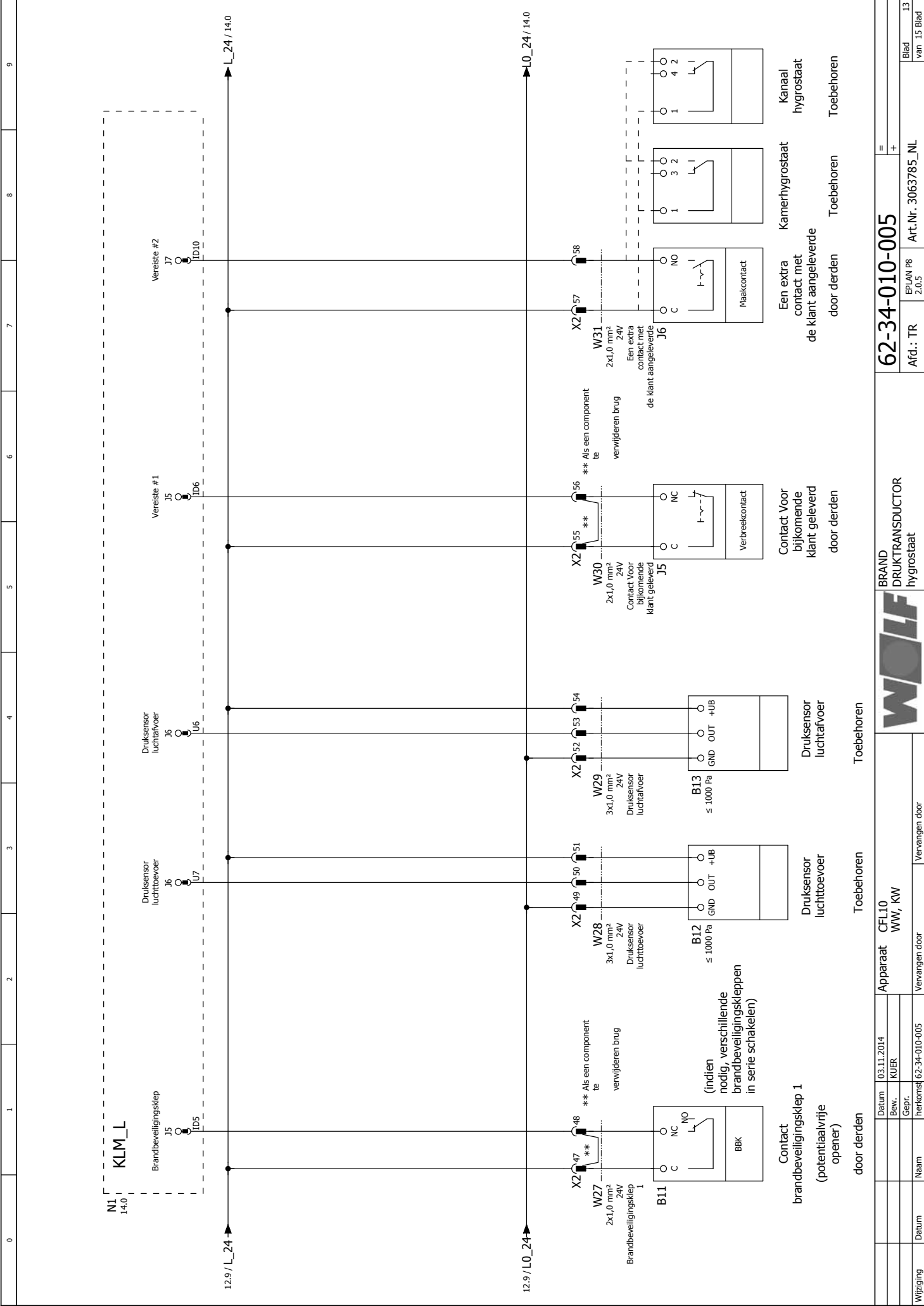

0	1	2	3	4	5	6	7	8	9
WOLF									
BRAND DRUKTRANSDUCTOR hygrostaat									
62-34-010-005									
Apparaat CFL10 WW, KW									
Datum 03.11.2014									
Bew. KUER									
Gepr. Vervangen door									
Naam Vervangen door									
Datum Vervangen door									
Herkomst 62-34-010-005									
Afd.: TR EPLAN P8 2.0.5									
Art.Nr. 3063785_NL									
Blad van 15 Blad									

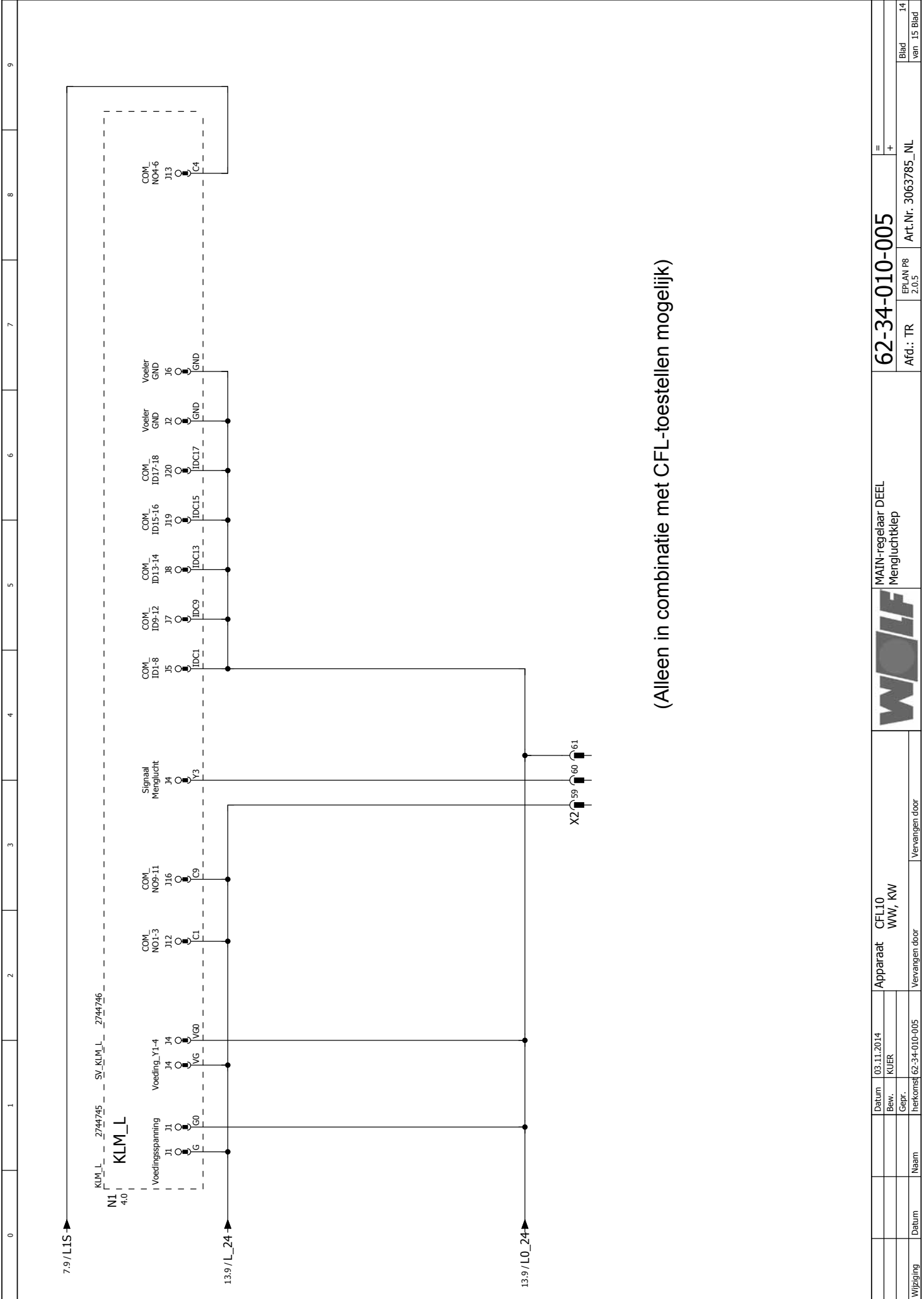

(Alleen in combinatie met CFL-toestellen mogelijk)

Wijziging		Datum	Naam	Gepl.	Bev.	Datum	Apparaat	CFL10 WW, KW		MAIN-regelaar DEEL Mengluchtklep		62-34-010-005		=	
						03.11.2014	KLIJER	Vervangen door		Vervangen door		Art.Nr. 3063785_NL		+	
												EPLAN P8 2.0.5		Blad van 15 Blad	



