

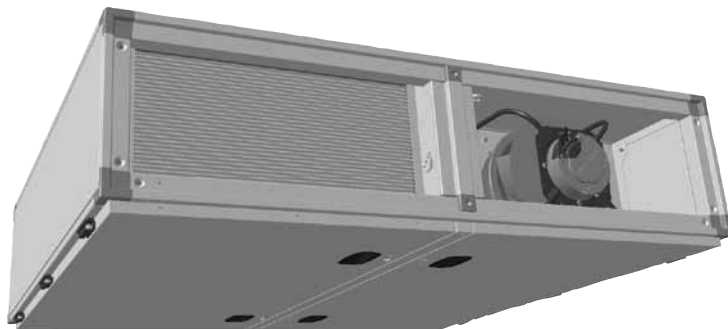

Schakelschema ventilatiestoel

CFL-32 Warmwaterregister





WOLF GmbH
 Industriestraße 1
 D-84048 Mainburg
 Tel. +49 (0)8751 74-0

Elektrotechnische documentatie

Apparaat	CFL-3 WW, KW
Tekeningnummer	62-34-030-001
Gemaakt op	17.07.2014
Bewerkt op	28.05.2015
	Van (afkorting) KUER
	Aantal pagina's 15

Wijziging	Datum	30.10.2014	Apparaat	CFL-3	Titelblad/voorbeeld	62-34-030-001	EPLAN P8 2.0.5	Art.Nr. 3063982_NL	=	+	Blad van 15 Blad
	Bew.	EHM	WW, KW								
	Gepr.	62-34-030-001	Vervangen door	Vervangen door							



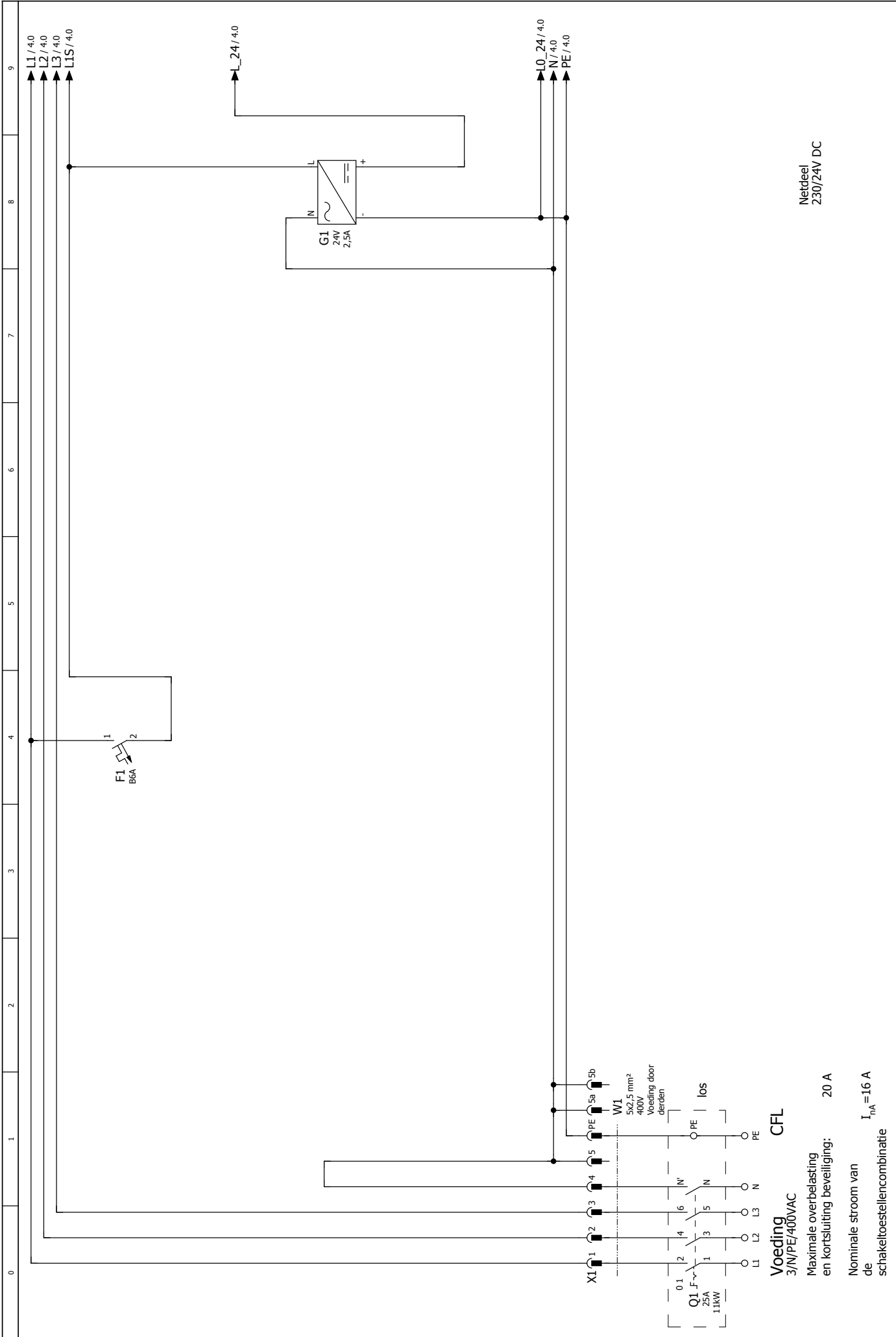

Netdeel
230/24V DC

Voeding
3/N/PE/400VAC

Maximale overbelasting
en kortsluiting beveiliging: 20 A

Nominale stroom van
de
schakeltoestellencombinatie
 $I_{nA} = 16 A$

Wijziging	Datum	Naam	herkomst#	62-34-030-001	Vervangen door	Apparaat	CFL-3 WW, KW	04.11.2014 KUER	Datum	04.11.2014
					Vervangen door					
								WOLF VOEDING HOOFDSCHAKELAAR STUURTRAFO		
								62-34-030-001		
								Afd.: TR EPLAN P8 2.0.5		
								Art.Nr. 3063982_NL		
								= +		
								Blad van 15 Blad 3		

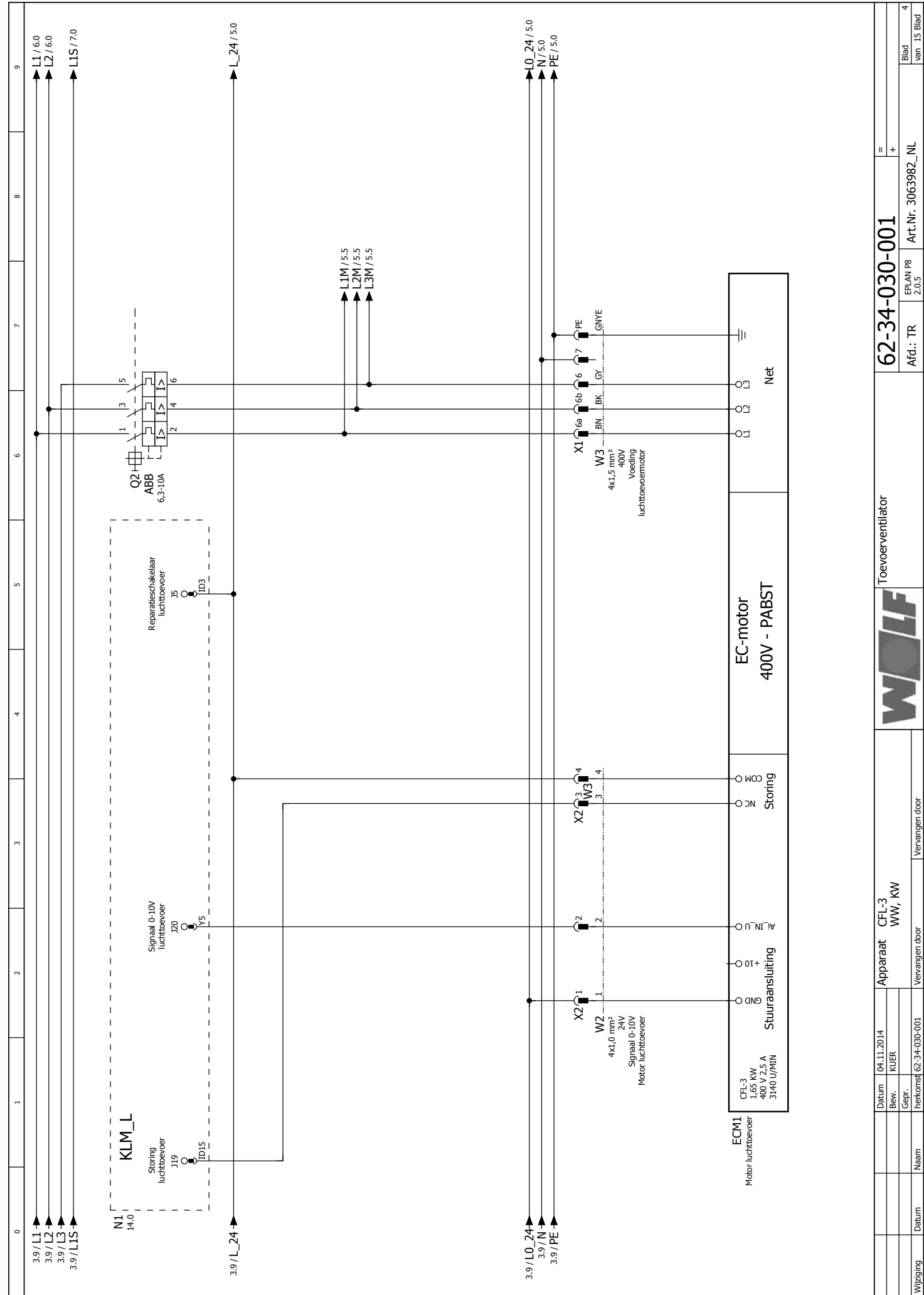

Datum	04.11.2014	Apparaat	CFL-3	Toevoerventilator	62-34-030-001	=
Bew.	KLIJER		WW, KW			+
Gepl.						
Naam						
Datum						
Wijziging						
				Vervangen door	Vervangen door	
				Afd.: TR	EPJAN P8	
				Art.Nr. 3063982_NL		
						Blad
						van 15 Blad
						4

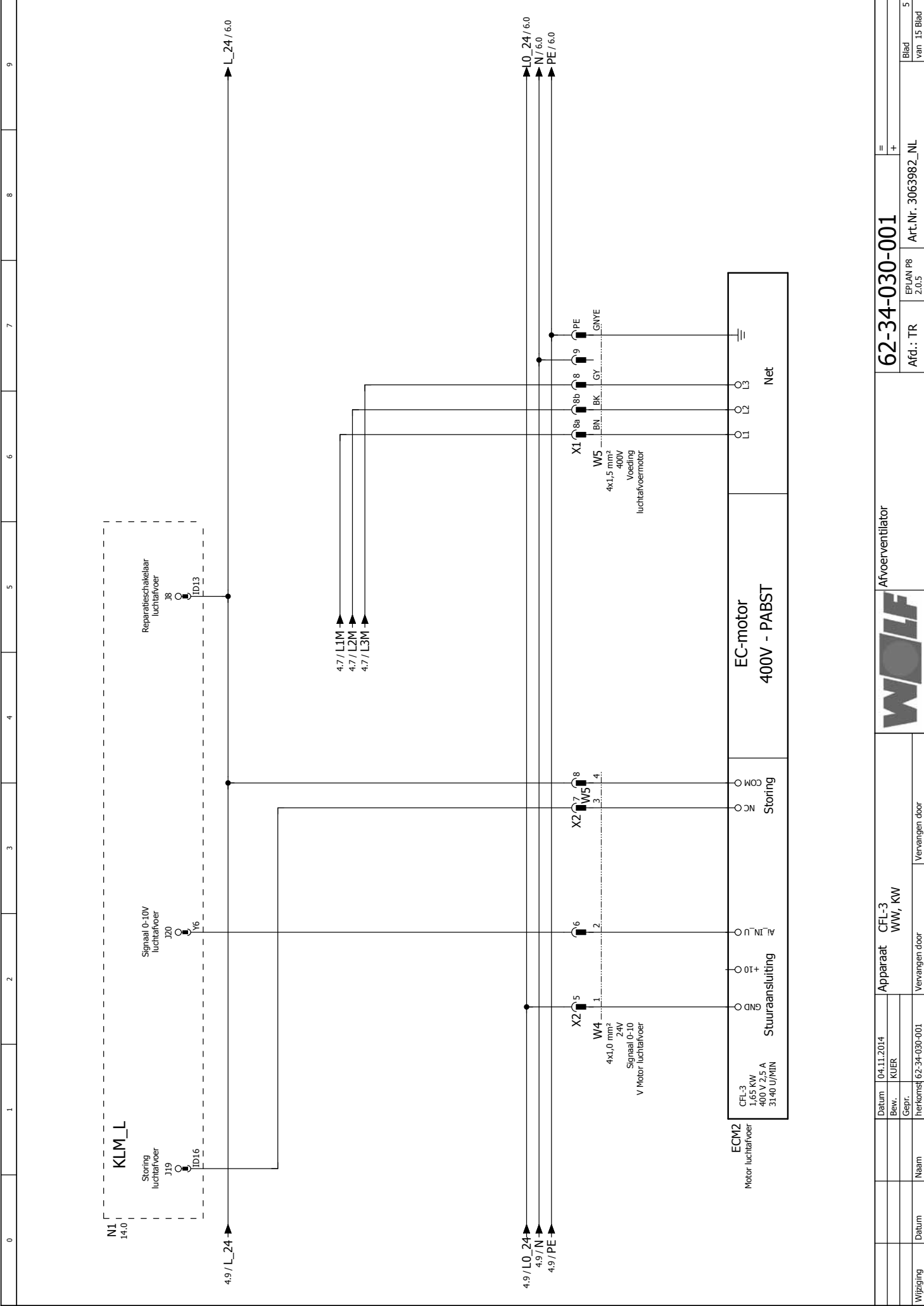

Wijziging	Datum	Naam	herkomst	62-34-030-001	Vervangen door	Vervangen door
	Datum	04.11.2014	Apparaat	CFL-3		
	Bew.	KUER		WW, KW		
				WOLF		
				Afvoerventilator		
				62-34-030-001		
				= +		
				Afd.: TR		
				EPLAN P8		
				2.0.5		
				Art.Nr. 3063982_NL		
				Blad		
				van 15 Blad		

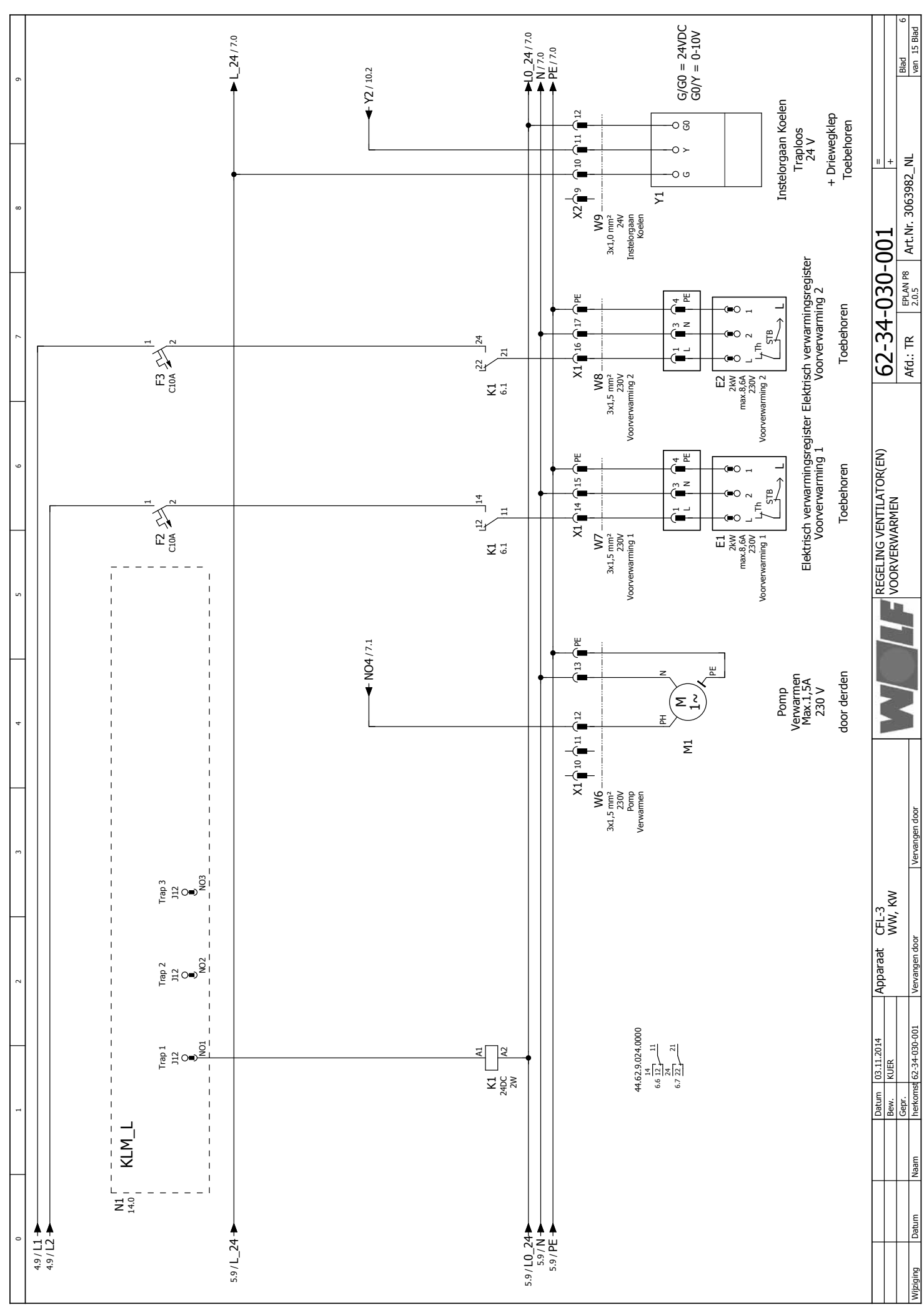

Wijziging	Datum	Naam	Gepr.	Bew.	Datum	Apparaat	CFL-3 WW, KW	Vervangen door	Vervangen door	
				KUIJER	03.11.2014					
							REGELING VENTILATOR(EN) VOORVERWARMEN			
							62-34-030-001			
							Afd.: TR	EP/JAN P8 2.0.5	Art.Nr. 3063982_NL	Blad van 15 Blad

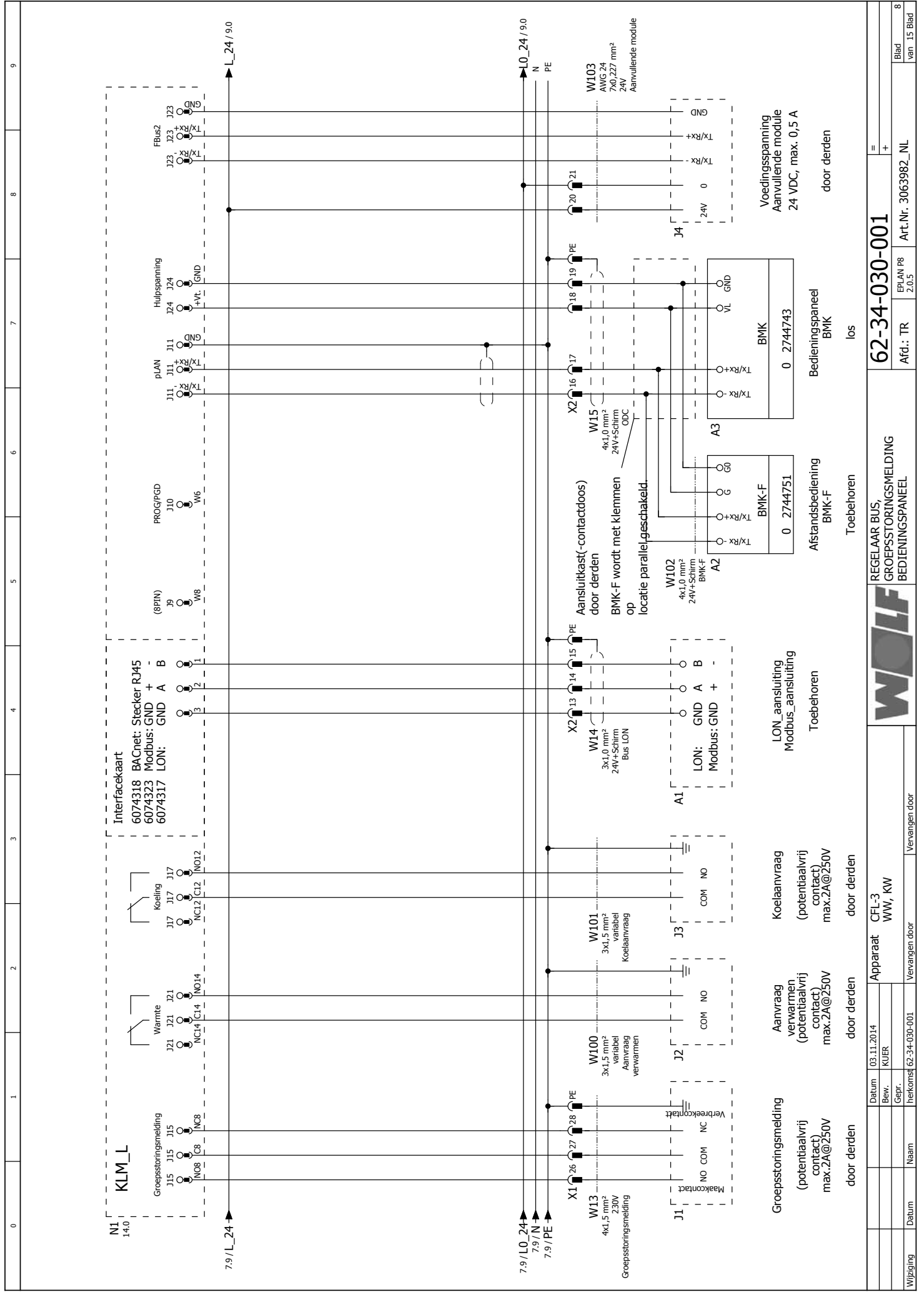

Blad	van 15 Blad	8
Art.Nr.	3063982_NL	
ER/JAN P8	2.0.5	
62-34-030-001		= +
Afd.:	TR	
Toebehooren los		
Toebehooren		
LON aansluiting Modbus aansluiting		
Koelaanvraag (potentiaalvrij contact) max.2A@250V		door derden
Aanvraag verwarmen (potentiaalvrij contact) max.2A@250V		door derden
Groepsstoringmelding (potentiaalvrij contact) max.2A@250V		door derden
Datum	03.11.2014	Apparaat
Bew.	KLIJER	CFL-3
Gepr.		WW, KW
Vervangen door		Vervangen door
Naam		
Datum		



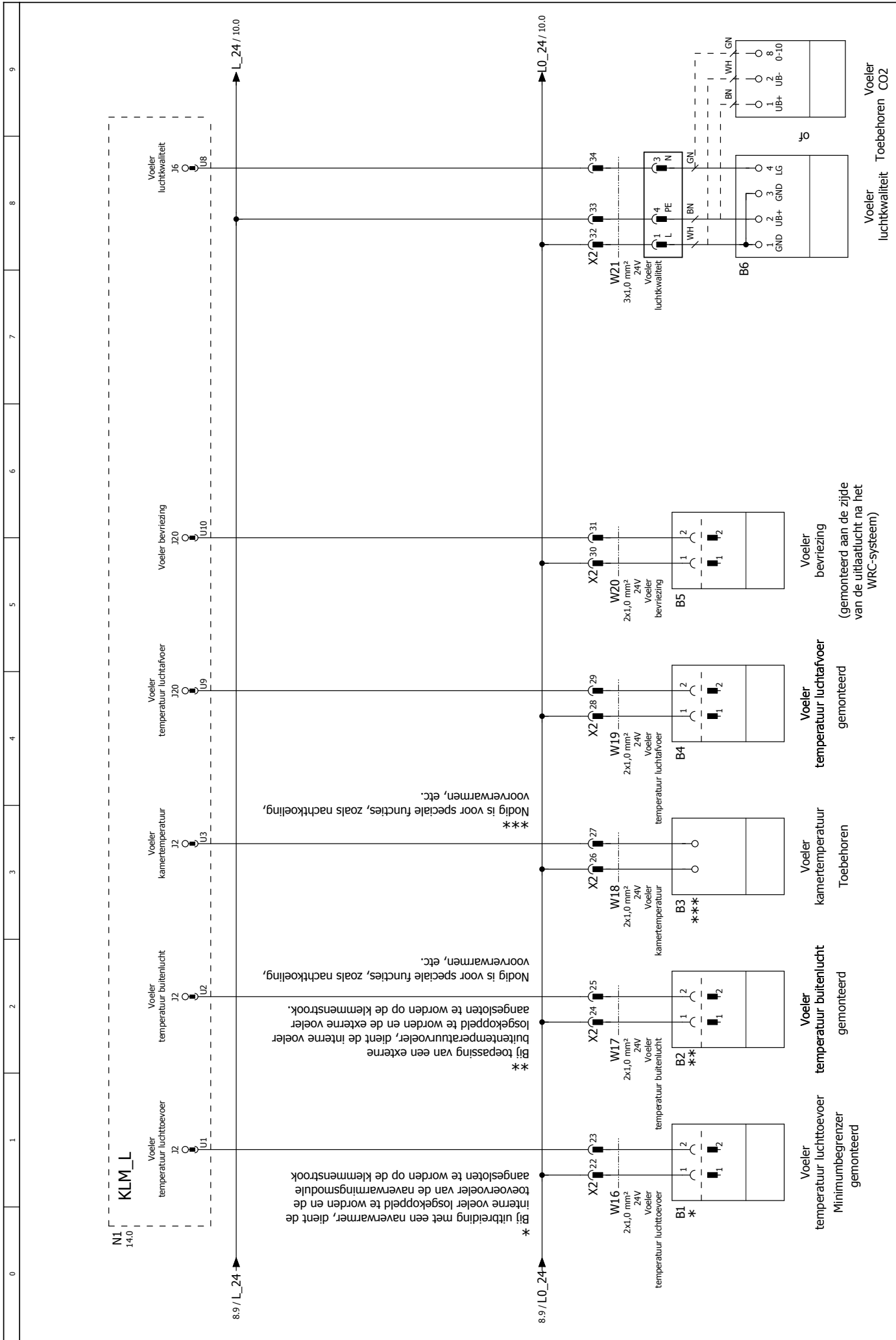

0	1	2	3	4	5	6	7	8	9
<p>NI 14.0 KLM_L</p> <p>Voeler temperatuur luchttoevoer U1</p> <p>Voeler temperatuur buitenlicht U2</p> <p>Voeler kamertemperatuur U3</p> <p>Voeler temperatuur luchttoevoer U9</p> <p>Voeler bevestiging U10</p> <p>Voeler luchtkwaliteit U8</p> <p>Voeler luchtkwaliteit U8</p> <p>8.9 / L0_24 →</p> <p>8.9 / L_24 ←</p> <p>8.9 / L0_24 →</p> <p>8.9 / L_24 ←</p> <p>W16 2x1,0 mm² 24V Voeler temperatuur luchttoevoer</p> <p>W17 2x1,0 mm² 24V Voeler temperatuur buitenlicht</p> <p>W18 2x1,0 mm² 24V Voeler kamertemperatuur</p> <p>W19 2x1,0 mm² 24V Voeler temperatuur luchttoevoer</p> <p>W20 2x1,0 mm² 24V Voeler bevestiging</p> <p>W21 3x1,0 mm² 24V Voeler luchtkwaliteit</p> <p>B1 * Voeler temperatuur luchttoevoer</p> <p>B2 *** Voeler temperatuur buitenlicht</p> <p>B3 *** Voeler kamertemperatuur</p> <p>B4 Voeler temperatuur luchttoevoer</p> <p>B5 Voeler bevestiging</p> <p>B6 Voeler luchtkwaliteit</p> <p>Voeler temperatuur buitenlicht gemonteerd</p> <p>Voeler kamertemperatuur Toebehoren</p> <p>Voeler temperatuur luchttoevoer gemonteerd</p> <p>Voeler bevestiging (gemonteerd aan de zijde van de uitlaatlucht na het WRC-systeem)</p> <p>Voeler luchtkwaliteit Toebehoren CO2</p> <p>Voeler CO2</p>									
<p>WOLF</p> <p>TEMPERATUURSENSOR LUCHTKWALITEIT CO2</p> <p>62-34-030-001</p> <p>Afd.: TR EPLAN P8 2.0.5 Art.Nr. 3063982_NL</p> <p>Blad van 15 Blad 9</p>									
<p>Datum 04.11.2014</p> <p>Bew. KLER</p> <p>Gepr. 62-34-030-001</p> <p>herkomsel Vervangen door</p> <p>Apparaat CFL-3 WW, KW</p> <p>Vervangen door</p>									

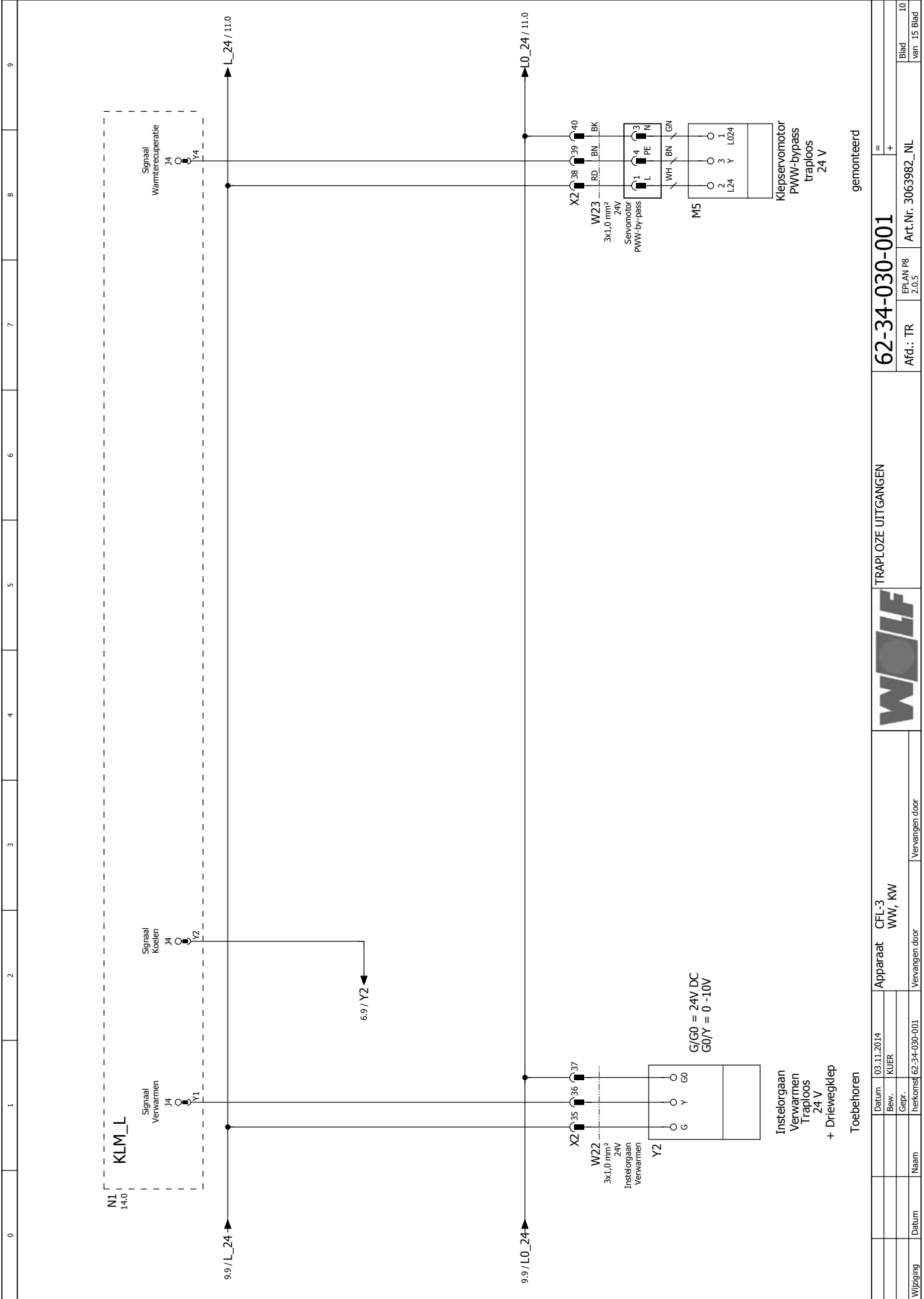

0	1	2	3	4	5	6	7	8	9
WOLF TRAPLOZE UITGANGEN									
62-34-030-001									
gemonoteerd									
Klepservomotor PWM-by-pass traploos 24 V									
Instelorgaan Verwarmen Traploos 24 V + Driewegklep Toebereiden									
G/G0 = 24V DC G0/Y = 0 -10V									
Apparaat CFL-3 WW, KW									
Datum 03.11.2014									
Bew. KLIJER									
Gepl. []									
Naam []									
Thetkoms[62-34-030-001									
Vervangen door []									
Vervangen door []									
Afd.: TR									
EPJAN P8 2.0.5									
Art.Nr. 3063982_NL									
Blad van 15 Blad									

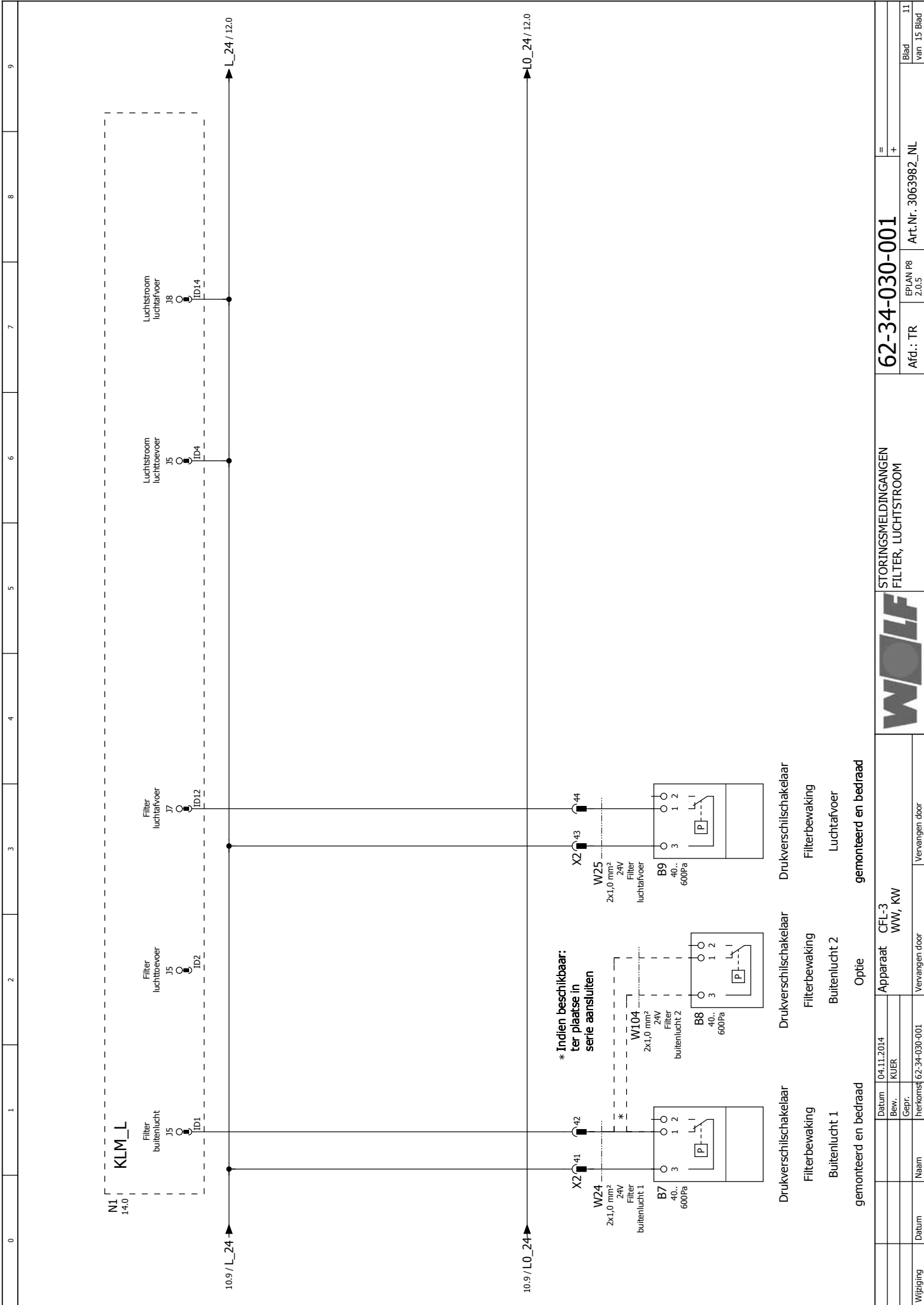

Wijziging	Datum	Naam	herkomst	62-34-030-001	Vervangen door
	Datum	Bew.	KUER	CFL-3	Apparaat
				WW, KW	
					Vervangen door
					Vervangen door
WOLF					
STORINGSMELDINGANGEN FILTER, LUCHTSTROOM					
				62-34-030-001	= +
				Afd.: TR	EPLAN P8
				2.0.5	Art.Nr. 3063982_NL
					Blad
					van 15 Blad
					11

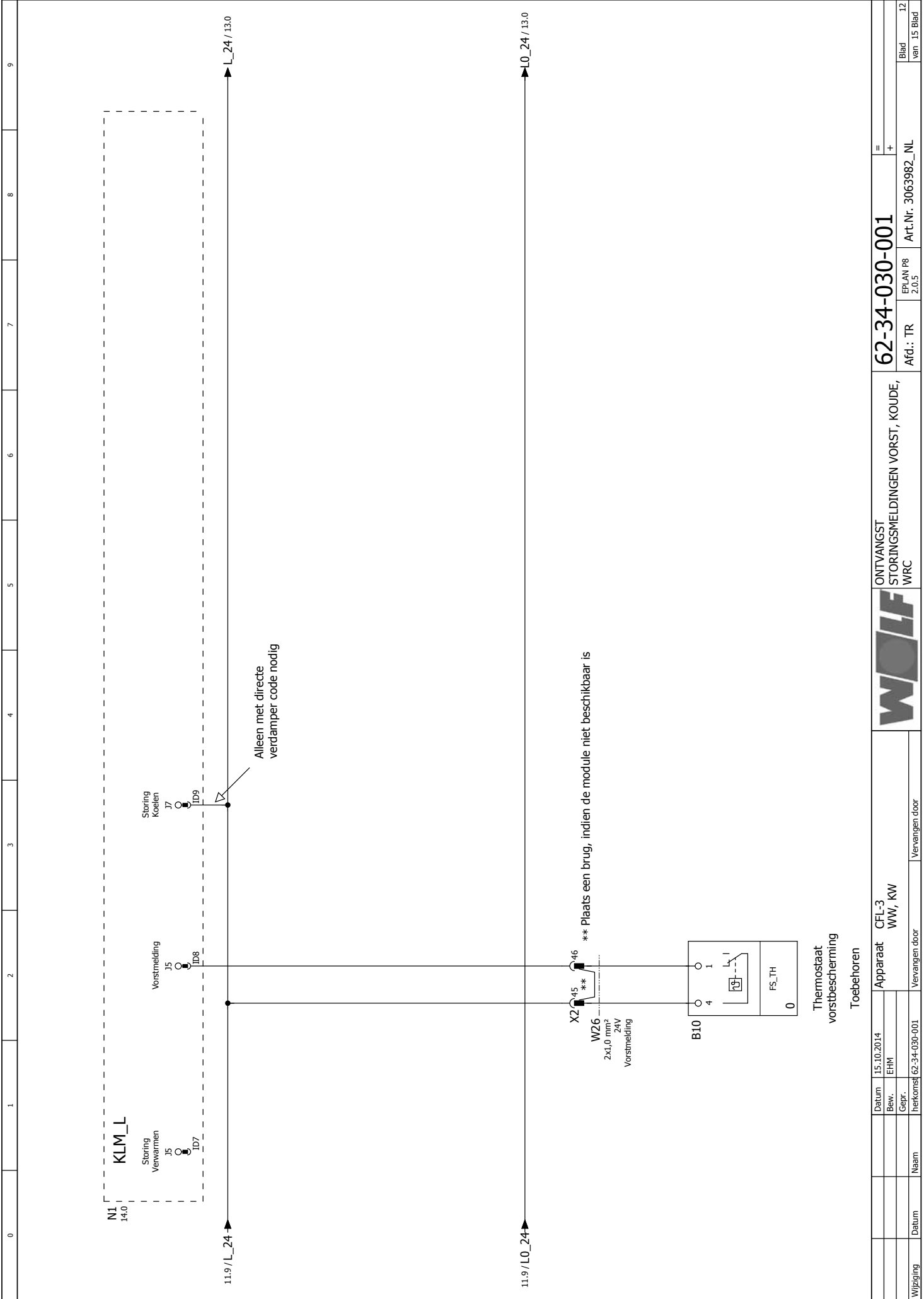

ONTVANGST
STORINGSMELDINGEN VORST, KOUDE,
WRC

62-34-030-001

Afd.: TR
EPJAN P8
2.0.5
Art.Nr. 3063982_NL

Blad
van 15 Blad

Apparaat
CFL-3
WW, KW

Datum 15.10.2014
Bew. EHM
Gepl. 62-34-030-001

Vervangen door

Vervangen door

